

Induction motors fed by PWM frequency inverters

■ Technical guide

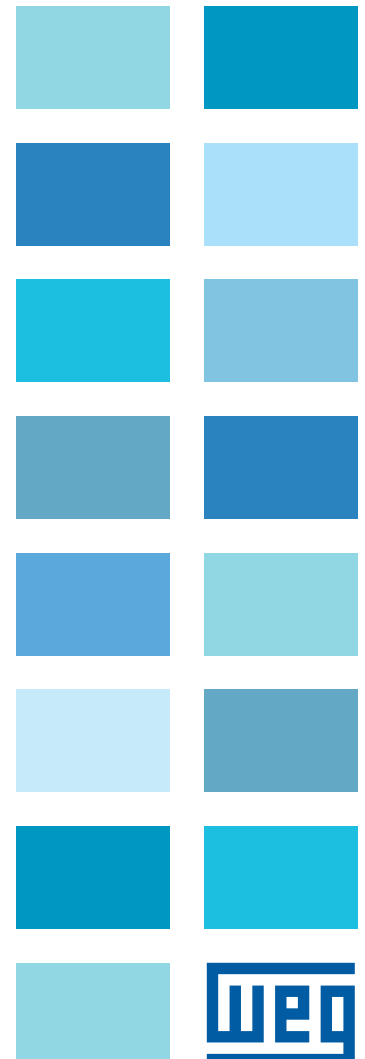
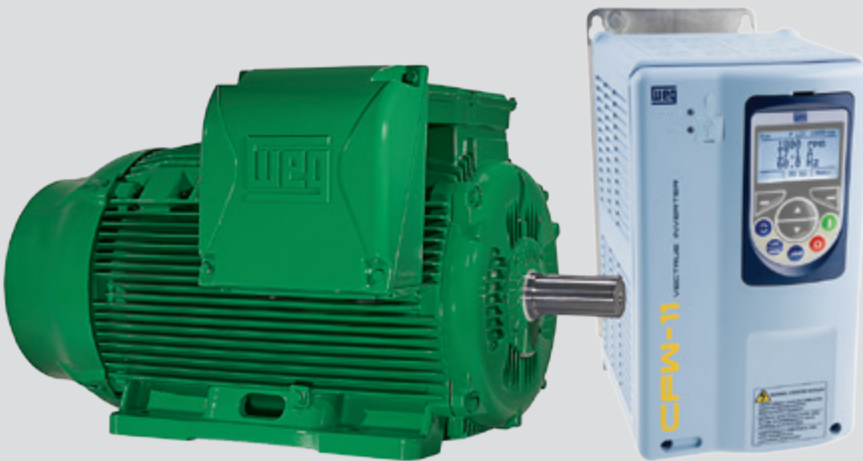

Table of contents

1	Introduction.....	4
2	Normative Aspects.....	5
2.1	NEMA MG1 - Motors and generators / “United States”.....	5
2.2	NEMA - Application Guide for AC Adjustable Speed Drive Systems.....	5
2.3	IEC 60034 - Rotating Electrical Machines / “Internacional”.....	5
2.4	Other technical documents of reference.....	5
3	Induction machines speed variation.....	5
4	Characteristics of PWM frequency inverters.....	7
4.1	General.....	7
4.2	Control Types.....	8
5	Interaction between inverter and AC power line.....	8
5.1	Harmonics.....	8
5.1.1	Normative considerations about the harmonics.....	9
5.2	Line reactor / DC bus choke.....	9
6	Interaction between inverter and motor.....	10
6.1	Harmonics influencing motor performance.....	10
6.1.1	Normative considerations about the inverter output harmonics.....	10
6.2	Considerations regarding energy efficiency.....	11
6.2.1	The influence of the speed variation on the motor efficiency.....	12
6.2.2	Normative considerations about the efficiency of inverter fed motors.....	12
6.3	Influence of the inverter on the temperature rise of the windings.....	13
6.4	Criteria regarding the temperature rise of WEG motors on VSD applications.....	13
6.4.1	Torque derating.....	13
6.4.2	Breakaway torque.....	14
6.4.3	Breakdown torque.....	15
6.5	Influence of the inverter on the insulation system.....	15
6.5.1	Rise Time.....	15
6.5.2	Cable length.....	16
6.5.3	Minimum time between successive pulses (MTBP).....	17
6.5.4	Switching frequency (fs).....	18
6.5.5	Multiple motors.....	18
6.6	Criteria regarding the insulation system of WEG motors on VSD applications.....	18
6.7	Normative considerations about the insulation system of inverter fed motors.....	18
6.8	Recommendations for the cables connecting WEG motors to inverters.....	19
6.8.1	Cable types and installation recommendations.....	20
6.9	Influence of the inverter on the motor shaft voltage and bearing currents.....	20
6.9.1	Common mode voltage.....	21
6.9.2	Equivalent circuit of the motor for the high frequency capacitive currents.....	21
6.9.3	Methods to reduce (or mitigate) the bearings currents in inverter fed motors.....	22
6.10	Criteria regarding protection against bearing currents (shaft voltage) of WEG motors on VSD applications.....	23
6.11	Normative considerations about the current flowing through the bearings of inverter fed motors.....	23
6.12	Influence of the inverter on the motor acoustic noise.....	23
6.13	Criteria regarding the noise emitted by WEG motors on VSD applications.....	23
6.14	Normative considerations about the noise of inverter fed motors.....	24

6.15	Influence of the inverter on the mechanical vibration of the motor.....	24
6.16	Criteria regarding the vibration levels presented by WEG motors on VSD applications.....	24
6.17	Normative considerations about mechanical vibration of inverter fed motors.....	24
7	Interaction between motor and driven load.....	25
7.1	Load types.....	25
7.1.1	Variable torque loads.....	25
7.1.2	Constant torque loads.....	25
7.1.3	Constant horsepower loads.....	26
7.2	Speed duties.....	26
7.2.1	Variable speed duty.....	26
7.2.2	Continuous speed duty.....	26
8	Dimensioning and analysis of actual drive system applications – Practical examples.....	26
8.1	Constant torque application - compressor.....	26
8.1.1	Example.....	26
8.1.2	Solution.....	26
8.2	Squared torque application - centrifugal pump.....	27
8.2.1	Example.....	27
8.2.2	Solution.....	27
8.3	Special application - long cable.....	29
8.3.1	Example.....	29
8.3.2	Solution.....	29
8.4	Variable torque / variable speed application - textile industry.....	30
8.4.1	Example.....	30
8.4.2	Solution.....	31
8.5	Example considering the use of WEG Optimal Flux.....	32
8.5.1	Example.....	32
8.5.2	Solution.....	32
9	Recommendations for the measurement of PWM waveforms.....	32
9.1	Warning.....	32
9.2	Instrumentation.....	32
9.3	Parameter measurements.....	33
9.4	Grounding considerations.....	33
9.4.1	Grounding of control.....	33
9.4.2	Grounding of motor.....	33
9.5	Measurement procedures.....	33
9.5.1	Waveform visualization.....	33
9.5.2	Oscilloscope scale setting.....	33
9.5.3	Triggering.....	33
10	Conclusion.....	34
11	Bibliography.....	35

1 Introduction



The number of industry applications in which induction motors are fed by static frequency inverters is growing fast and, although much has already been done within this field, there is still a lot to be studied/understood regarding such applications. The advance of variable speed drives systems engineering increasingly leads to the need of specific technical guidance provision by electrical machines and drives manufacturers, so that such applications can be suitably designed in order to present actual advantages in terms of both energy efficiency and costs.

This technical guide aims to clarify the main aspects concerning applications of low voltage (≤ 690 V) induction motors with static frequency inverters supply, for frames \leq IEC 355 (NEMA 587), in a didactic and concise approach.

First of all the principal and most broadly followed international standards about the subject are mentioned.

Then the theoretical basis of speed variation on induction machines by means of indirect static inverters is presented, as well as the fundamental characteristics of electronic inverters.

Once the basics of adjustable speed drives are known, the behavior of the whole power system is analyzed. Each component of the power system (AC power line - frequency inverter - induction motor - load) is focused, as well as the overall interactions between them, resulting from speed variation. In this manner the whole drive system can be well understood.

At last examples of VSD systems designs are presented, for a better understanding of the matters exposed throughout the document.

Always looking out for a technical elucidation as complete as possible along this guide, some controversial points are emphasized. Divergences existing among distinct standardization organisms are discussed and WEG's point of view is explained.



2 Normative Aspects

2.1 NEMA MG1 - Motors and generators / “United States”

- **Parte 30** - Application considerations for constant speed motors used on a sinusoidal bus with harmonic content and general purpose motors used with adjustable-frequency controls or both (2006)
- **Parte 31** - Definite-purpose inverter-fed polyphase motor (2006)

2.2 NEMA - Application Guide for AC Adjustable Speed Drive Systems (2001)

2.3 IEC 60034 - Rotating Electrical Machines / “International”

- **Parte 17** - Cage induction motors when fed from inverters – application guide (2006)
- **Parte 25** - Guide for the design and performance of cage induction motors specifically designed for inverter supply (2007)

2.4 Other technical documents of reference

- GAMBICA/REMA Technical Guides for Variable Speed Drives and Motors
- GAMBICA/REMA Technical Reports for Variable Speed Drives and Motors
- CSA C22.2 No.100-2004 Item 12 (Canada) “Motors and Generators – Industrial Products”
- JEM-TR 148-1986 (Japan) “Application guide for inverter drive (general-purpose inverter)”
- IEC 60034-18-41 – Qualification and design tests for Type I electrical insulation systems used in rotating electrical machines fed from voltage inverters
- Papers and books related to this subject

3 Induction machines speed variation

For an induction motor, rotor speed, frequency of the voltage source, number of poles and slip are interrelated according to the following equation:

$$n = \frac{120 f_1}{p} (1-s)$$

where:

n : mechanical speed (rpm)

f_1 : fundamental frequency of the input voltage (Hz)

p : number of poles

s : slip

The analysis of the formula above shows that the mechanical speed of an induction motor is a function of three parameters. Thus the change of any of those parameters will cause the motor speed to vary as per the table below.

Speed variation	
Parameter	Application characteristics
Number of poles	Discrete variation
	Oversizing
Slip	Continuous variation
	Rotor losses
	Limited frequency range
Voltage frequency	Continuous variation
	Utilization of STATIC FREQUENCY Inverters!



The utilization of static frequency inverters comprehends currently the most efficient method to control the speed of induction motors. Inverters transform a constant frequency-constant amplitude voltage into a variable (controllable) frequency-variable (controllable) amplitude voltage. The variation of the power frequency supplied to the motor leads to the variation of the rotating field speed, which modifies the mechanical speed of the machine.

The torque developed by the induction motor follows the equation below:

$$T = k_1 \cdot \phi_m \cdot I_2$$

Despising the voltage drop caused by the stator impedance, the magnetizing flux is found to be:

$$\phi_m = k_2 \cdot \frac{V_1}{f_1}$$

where:

T : torque available on the shaft (N.m)

ϕ_m : magnetizing flux (Wb)

I_2 : rotor current (A) → depends on the load!

V_1 : stator voltage (V)

k_1 e k_2 : constants → depend on the material and on the machine design!

Considering a constant torque load and admitting that the current depends on load (therefore practically constant current), then varying proportionally amplitude and frequency of the voltage supplied to the motor results in constant flux and therefore constant torque while the current remains unchanged. So the motor provides continuous adjustments of speed and torque with regard to the mechanical load. Losses can be thus minimized in accordance with the load conditions by keeping the slip constant at any speed, for a given load.

The curves below are obtained from the equations above.

The ratio V_1/f_1 is kept constant up to the motor base (rated) frequency. From this frequency upwards the voltage is kept constant at its base (rated) value, while the frequency applied on the stator windings keeps growing, as shown next.

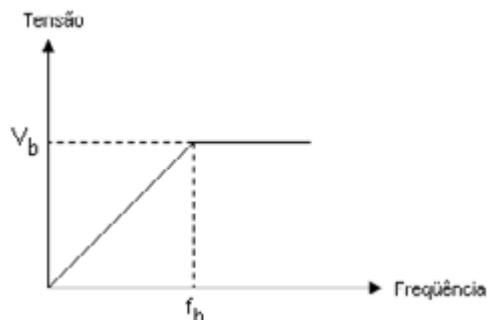

Thereby the region above the base frequency is referred to as field weakening, in which the flux decreases as a result of frequency increase, causing the motor torque to decrease gradually. The typical torque versus speed curve of an

inverter fed induction motor is illustrated below.

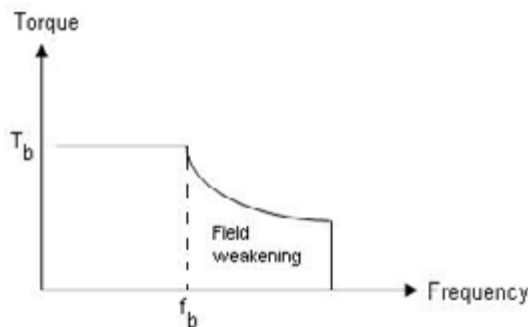

It comes out that torque is kept constant up to the base frequency and beyond this point it falls down (weakening field). Since the output is proportional to torque times speed, it grows linearly up to the base frequency and from that point upwards it is kept constant. This is summarized by the graph beside.

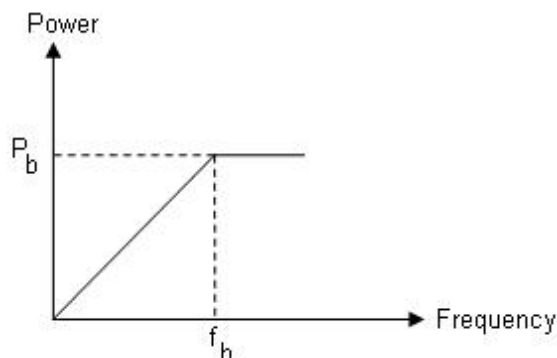

The number of variable speed applications controlled by means of a frequency inverter has increased significantly over the recent years. This may be explained by the many benefits provided by such applications:

- Aloff control – the control can be installed remotely at a suitable location, keeping just the motor in the processing area – on the contrary of hydraulic and mechanical varying speed systems.
- Aloff control – the control can be installed remotely at a suitable location, keeping just the motor in the processing area – on the contrary of hydraulic and mechanical varying speed systems.
- Cost reduction – direct on line startings of induction motors cause current peaks that harm the motor as well as other electric equipments linked to the electrical system. Static frequency inverters provide softer startings, resulting in cost reduction with regard to maintenance.
- Gain of productivity – industrial systems are often oversized due to an expectation of future production increase. Static inverters allow the proper regulation of the operational speed according to the equipments available and the production needs.
- Energy Efficiency – the power system global efficiency depends not only on the motor, but also on the control. Static inverters are high efficiency apparatuses, reaching typically 97% or more. Induction motors also present high efficiency levels, reaching up to 95% or even more in larger

machines operating at rated conditions. When speed variation is required, the output changes in an optimized way, directly affecting the energy consumption and leading to high efficiency levels performed by the system (inverter + motor).

- **Versatility** – static frequency inverters suit both variable and constant torque loads. With variable torque loads (low torque demand at low speeds) the motor voltage is decreased to compensate for the efficiency reduction normally resultant from load reduction. With constant torque (or constant power) loads the system efficiency improvement comes from the feasibility of continuous adjustment of speed, with no need to use multiple motors or mechanical variable speed systems (such as pulleys and gears), which introduce additional losses.

- **High quality** – the accurate speed control obtained with inverters results in process optimization, providing a final product of better quality.
- **Aloof control** – the control can be installed remotely at a suitable location, keeping just the motor in the processing area – on the contrary of hydraulic and mechanical varying speed systems.

4 Characteristics of PWM frequency inverters

4.1 General

PWM voltage source static frequency inverters presently comprehend the most used equipments to feed low voltage industrial motors in applications that involve speed variation. They work as an interface between the energy source (AC power line) and the induction motor.

In order to obtain an output signal of desired voltage and frequency, the input signal must accomplish three stages within a frequency inverter:

- **Diode bridge** - Rectification of the AC input voltage -

constant amplitude and frequency - coming from the power grid;

- **DC link or filter** - Regulation/smoothing of the rectified signal with energy storage through a capacitor bank;
- **IGBT power transistors** – Inversion of the voltage coming from the link DC into an alternate signal of variable amplitude and frequency.

The following diagram depicts the three stages of an indirect frequency inverter.

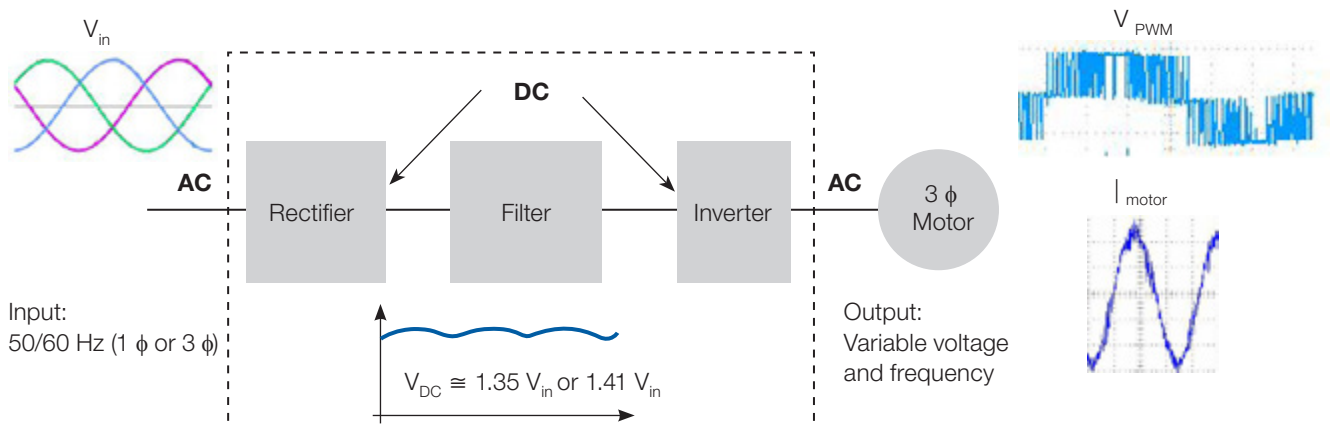

NOTES:

- Under light load (or at no load) conditions, the DC link voltage tends to stabilize at $\sqrt{2} V_{rede} \cong 1,41 V_{rede}$
However, when the motor drives heavier loads (for instance, at full load), the DC link voltage tends to the value $(3/\pi) \sqrt{2} V_{rede} \cong 1,35 V_{rede}$
- The criteria used to define the insulation system of WEG motors fed by inverters, presented further on, consider the highest of those values (1.41Vin), which is more critical to the motor. In this way WEG motors attend both situations satisfactorily.

4.2 Control Types

There are basically two inverter control types: scalar (open loop) and vector (open or closed loop).

The scalar control is based on the original concept of a frequency inverter: a signal of certain voltage/frequency ratio is imposed onto the motor terminals and this ratio is kept constant throughout a frequency range, in order to keep the magnetizing flux of the motor practically unchanged. It is generally applied when there is no need of fast responses to torque and speed commands and is particularly interesting when there are multiple motors connected to a single drive. The control is open loop and the speed precision obtained is a function of the motor slip, which depends on the load, since the frequency is imposed on the stator windings. In order to improve the performance of the motor at low speeds, some drives make use of special functions such as slip compensation (attenuation of the speed variation as function of load) and torque boost (increase of the V/f ratio to

compensate for the voltage drop due to the stator resistance), so that the torque capacity of the motor is maintained. This is the most used control type owing to its simplicity and also to the fact that the majority of applications do not require high precision or fast responses of the speed control.

The vector control enables fast responses and high level of precision on the motor speed and torque control. Essentially the motor current is decoupled into two vectors, one to produce the magnetizing flux and the other to produce torque, each of them regulated separately. It can be open loop (sensorless) or closed loop (feedback).

- Speed feedback – a speed sensor (for instance, an incremental encoder) is required on the motor. This control mode provides great accuracy on both torque and speed of the motor even at very low (and zero) speeds.
- Sensorless – simpler than the closed loop control, but its action is limited particularly at very low speeds. At higher speeds this control mode is practically as good as the feedback vector control.

The main difference between the two control types is that the scalar control considers only the magnitudes of the instantaneous electrical quantities (magnetic flux, current and voltage) referred to the stator, with equations based on the equivalent electrical circuit of the motor, that is, steady state equations. On the other hand, the vector control considers the instantaneous electrical quantities referred to the rotor linkage flux as vectors and its equations are based on the spatial dynamic model of the motor. The induction motor is seen by the vector control as a DC motor, with torque and flux separately controlled.

5 Interaction between inverter and AC power line

5.1 Harmonics

For the AC power line, the system (frequency inverter + motor) is a non-linear load whose current include harmonics (frequency components multiples of the power line frequency). The characteristic harmonics generally produced by the rectifier are considered to be of order $h = np \pm 1$ on the AC side, that is, on the power line (p is the number of pulses of the inverter and $n = 1, 2, 3$). Thus, in the case of a 6 diode (6 pulses) bridge, the most pronounced generated harmonics are the 5th and the 7th ones, whose magnitudes may vary from 10% to 40% of the fundamental component, depending on the power line impedance. In the case of rectifying bridges of 12 pulses (12 diodes), the most harmful harmonics generated are the 11th and the 13th ones. The higher the order of the harmonic, the lower can be considered its magnitude, so higher order harmonics can be filtered more easily. As the majority of drives manufacturers, WEG produces its low voltage standard inverters with 6-pulse rectifiers.

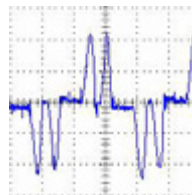

The power system harmonic distortion can be quantified by the THD (Total Harmonic Distortion), which is informed by the inverter manufacturer and is defined as:

$$THD = \sqrt{\sum_{h=2}^{\infty} \left(\frac{A_h}{A_1} \right)^2}$$

where:

A_h are the rms values of the non-fundamental harmonic components

A_1 is the rms value of the fundamental component

The waveform above is the input measured current of a 6-pulse PWM inverter connected to a low impedance power grid.

5.1.1 Normative considerations about the harmonics

The NEMA Application Guide for AC ASD Systems refers to IEEE Std.519 (1992), which recommends maximum THD levels for power systems ≤ 69 kV as per the tables presented next. This standard defines final installation values, so that each case deserves a particular evaluation. Data like the power line short-circuit impedance, points of common connection (PCC) of inverter and other loads, among others, influence on the recommended values.

Voltage harmonics	
Even components	3,0%
Odd components	3,0%
THD _{voltage}	5,0%

The maximum harmonic current distortion recommended by IEEE-519 is given in terms of TDD (Total Demand Distortion) and depends on the ratio (I_{SC} / I_L), where:

I_{SC} = maximum short-current current at PCC.

I_L = maximum demand load current (fundamental frequency component) at PCC.

Individual Odd Harmonics (Even harmonics are limited to 25% of the odd harmonic limits)						
Maximum harmonic current distortion in percent of I_L						
ISC / IL	< 11	11 ≤ h ≤ 17	17 ≤ h ≤ 23	23 ≤ h ≤ 35	35 ≤ h	TDD
< 20*	4.0	2.0	1.5	0.6	0.3	5.0
20 < 50	7.0	3.5	2.5	1.0	0.5	8.0
50 < 100	10.0	4.5	4.0	1.5	0.7	12.0
100 < 1000	12.0	5.5	5.0	2.0	1.0	15.0
> 1000	15.0	7.0	6.0	2.5	1.4	20.0

* All power generation equipment is limited to these values of current distortion, regardless of actual I_{SC} / I_L .

The documents mentioned from IEC, however, do not set limits for the harmonic distortion injected by inverters into the power line.

5.2 Line reactor / DC bus choke

Harmonic currents, which circulate through the power line impedances and depend on the rectifier input/output impedance values, cause harmonic voltage drops that distort the power supply voltage of the inverter and other loads connected to this line. These harmonic current and voltage distortions may increase the electrical losses in the installation, lowering the power factor and overheating components such as cables, transformers, capacitor banks, motors, etc.

The addition of a line reactor and/or a DC bus choke reduces the harmonic content of the current and increase the power factor. The DC bus choke has the advantage of not introducing a motor voltage drop but depending on the combination of its value with the power line impedance and the DC link capacitance values it may result in undesirable resonances within the overall system. On the other hand, the line reactor decreases the medium voltage of the intermediate circuit but attenuates more effectively power supply voltage transients. Besides that, it extends the semiconductors and the DC link capacitor bank lifetimes, as

a result of the decrease of both the rms current of the rectifying diodes and the current ripple through the middle circuit capacitors.

Converter input current

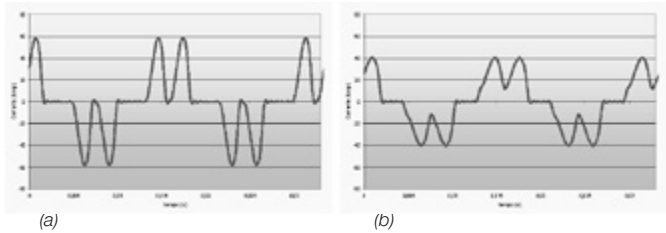

Converter input voltage

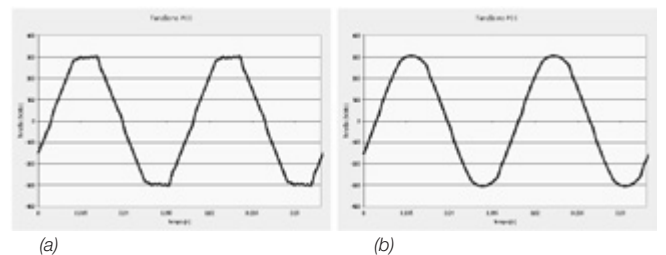

Current and voltage waveforms with (b) and without (a) line reactor. It can be seen that line reactors soften the peaks, thus reducing the harmonic content and the rms value of the input current. Additionally, diminution of the supply voltage waveform distortion is thereby caused.

A minimum line impedance that introduces a voltage drop from 1 to 2%, depending on the inverter size, is recommended in order to ensure the inverter lifetime.

As rule of thumb, it is recommended to add a line reactor to the existing power supply impedance (including transformers and cables) so that a total voltage drop of 2 to 4% is achieved. This practice is considered to result in a good compromise between motor voltage drop, power factor improvement and harmonic current distortion reduction.

The value of the line reactor needed for the desired voltage drop to be obtained can be calculated as follows:

$$L = \frac{(\text{voltage drop})_{\%} \cdot V_{\text{line}}}{\sqrt{3} \cdot 2 \cdot \pi \cdot f_{\text{line}} \cdot I_{\text{rated}}} \quad [\text{H}]$$

The (a) line reactor and (b) DC bus choke electrical installations are shown next.

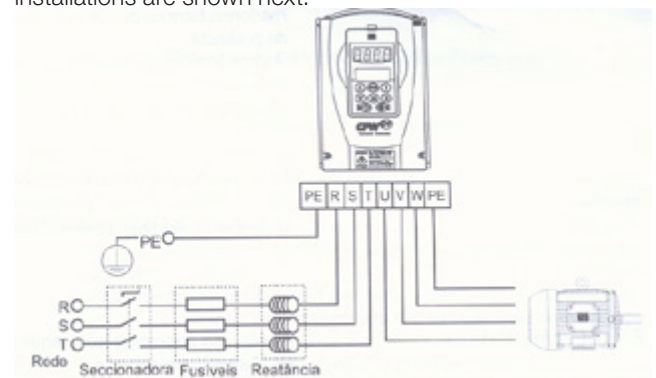

(a) Input line reactor connection

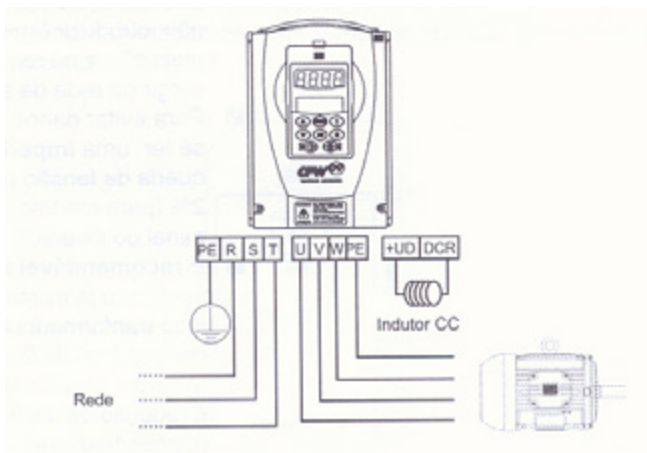

(b) DC bus choke connection

6 Interaction between inverter and motor

6.1 Harmonics influencing motor performance

The induction motor, when under PWM voltage coming from the inverter, is subjected to voltage harmonics (frequency components above the fundamental frequency). Depending on the type of PWM employed, the switching frequency and other peculiarities of the control, the motor may present efficiency decrease and losses, temperature, noise and vibration levels increase.

Furthermore other effects may appear when induction motors are fed by inverters. Insulation system dielectric stress and shaft voltages allied with potentially damaging bearing currents are well known side effects. Although not produced specifically by harmonics but by other matters that will soon be approached, these are important effects and should not be neglected. The motor current and voltage waveforms when under PWM supply are illustrated below.

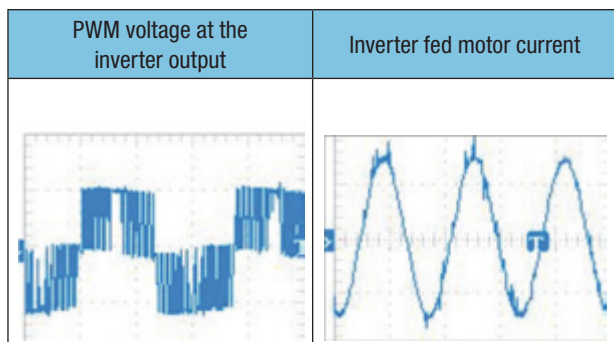

Then the motor fed by frequency inverter sees a pulsating (PWM) voltage and a practically sinusoidal current, so that the voltage harmonics generally present higher magnitudes than the current harmonics.

There are basically the following solutions to mitigate the harmonics generated by a PWM frequency inverter:

Methods of reduction of harmonics	Solution characteristics
Installation of output passive filters (L, LC (sinusoidal), dV/dt)	Installation costs increase
	Restrictions for vector control operation
	Voltage drop (motor horsepower reduction)
Use of multi-level inverters	Costs increase
	Inverter reliability decrease
	Control complexity increase
Pulse Width Modulation quality improvement (optimization of pulse patterns)	Space Vector Modulation (SVM)*
	Do not increase costs
	Voltage control upgrade
	Higher system (inverter + motor) efficiency
Switching frequency increase	Inverter efficiency decrease (higher switching losses)
	- Common mode leakage current flow increase

* All frequency inverters manufactured by WEG employ Space Vector Modulation.

6.1.1 Normative considerations about the inverter output harmonics

There is no international standardization defining maximum acceptable values for voltage and current harmonic distortion. However, the international standards do consider the increase of motor losses due to the non-sinusoidal supply.

IEC 60034-17 provides an example of motor losses increase owing to PWM supply. Motor info: 315 IEC frame, rated torque and speed values.

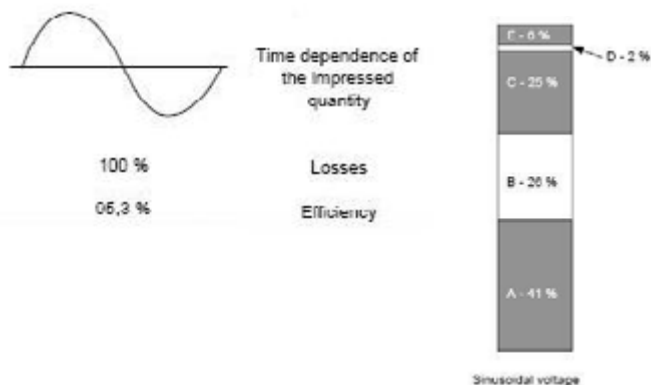

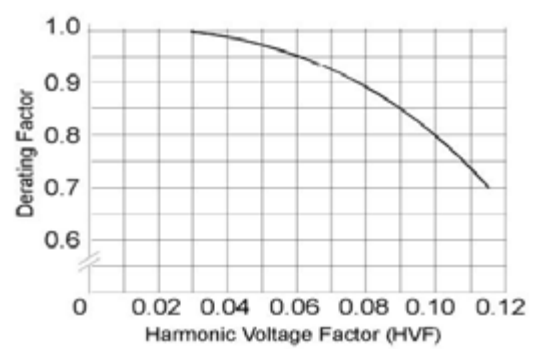
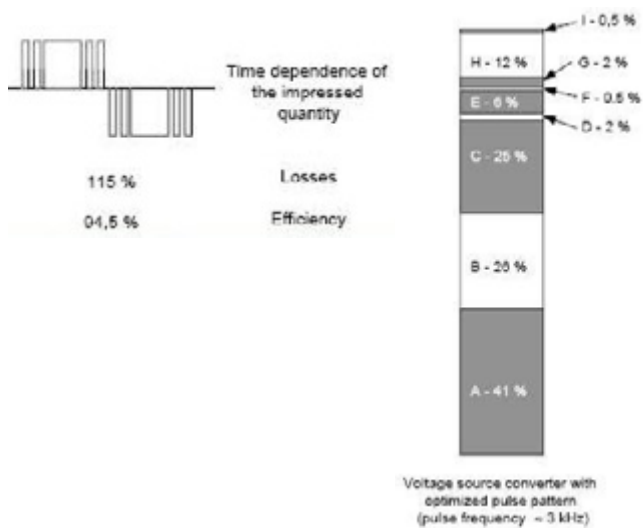

$$HVF = \sqrt{\sum_{n=5}^{\infty} \left(\frac{V_n}{n} \right)^2}$$

Losses caused by fundamental frequency

- A – Stator winding losses
- B – Rotor winding losses
- C – Iron losses
- D – Additional load losses
- E – Frictional losses

Losses caused by harmonics

- F – Stator winding losses
- G – Rotor winding losses
- H – Iron losses
- I – Additional load losses
- J – Commutation losses

NOTE: frame 315 (IEC) motor operating at rated speed and torque.

IEC 60034-25 illustrates the motor losses increase due to PWM supply by means of the following curves:

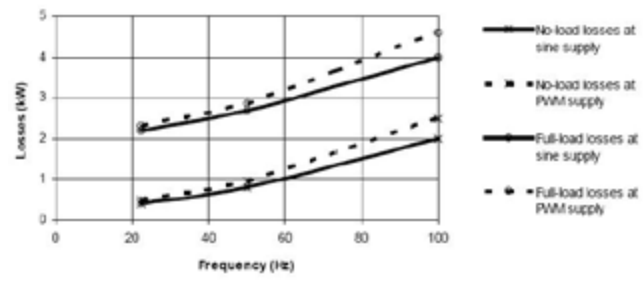

NEMA MG1 – Part 30 considers a derating factor (torque reduction) to avoid excessive overheating of a general purpose motor fed by converter, compensating for the circulation of harmonic currents due to the PWM voltage harmonic content:

Where:

- n: order of the odd harmonic, not including those divisible by three
- V_n: per unit magnitude of the voltage at the nth harmonic frequency

6.2 Considerations regarding energy efficiency

The lack of international standards that specify test procedures to evaluate the system (motor + inverter) efficiency allows such tests to be carried out in many different and non contestable ways. Therefore, the results obtained should not influence the acceptance (or not) of the motor, except under mutual accordance between customer and manufacturer. Experience shows the effectiveness of the considerations below.

- An induction motor fed by PWM voltage presents a lower efficiency level than when fed by purely sinusoidal voltage, due to the losses increase caused by harmonics;
- Anyway, when induction motors are fed by static inverters, the efficiency of the overall system, rather than the motor efficiency only, should be evaluated;
- Each case must be properly analyzed, taking into account characteristics of both the motor and the inverter, such as: operating frequency, switching frequency, speed range, load conditions and motor power, THD, etc.
- The measuring instrumentation is extremely important for the correct evaluation of electrical quantities on systems under PWM duty. True RMS meters must be used, in order to permit reliable measurements of power;
- Higher switching frequencies increase the motor efficiency and decrease the inverter efficiency (due to the increase of commutation losses).
- High efficiency motors keep their efficiency higher, compared to standard motors, when both are fed by inverters.

6.2.1 The influence of the speed variation on the motor efficiency

The effects of speed variation on the motor efficiency can be understood from the analysis of the behavior of the inverter fed motor output power as a function of its operation speed.

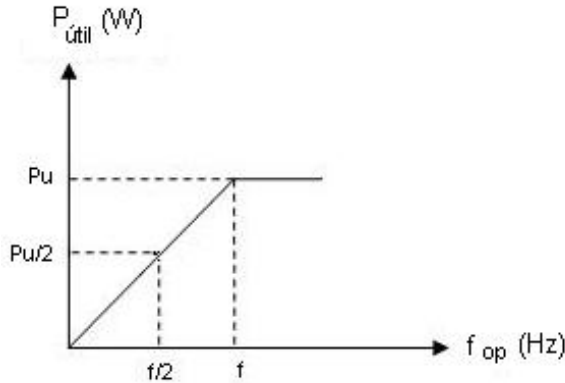

Supposing, for instance, a 60 Hz frequency base for the situations outlined above:

$$P_{60\text{Hz}} = P_u$$

$$P_{30\text{Hz}} = \frac{P_u}{\frac{60}{30}} = 0,5 P_u$$

Considering that the motor losses are essentially comprised of Joule losses (P_J) and iron losses (P_i) and assuming that the Joule losses prevail, then the motor efficiency fall at low speeds, where the motor output power is reduced and, despite the slight decrease of the iron losses (frequency dependant), the Joule losses (current square dependant) are kept nearly constant for a constant torque load, so that after all there is no significant variation of the overall losses.

The equations next explain that. Defining efficiency as:

$$\eta \% = \frac{P_{out}}{P_{in}} = \frac{P_{out}}{P_{out} + \sum Losses}$$

And, according to the exposed above,

$$\sum Losses \cong P_J + P_{iron} \quad (P_J > P_{iron})$$

Then the following situation results from speed reduction:

$$\left. \begin{array}{l} \downarrow P_{iron} + P_J \cong \text{constant} \quad (P_J \gg P_{iron}) \Rightarrow \sum Losses \cong \text{constant} \\ \downarrow P_{out} \end{array} \right\} \downarrow \eta \%$$

6.2.2.1 Numerical example

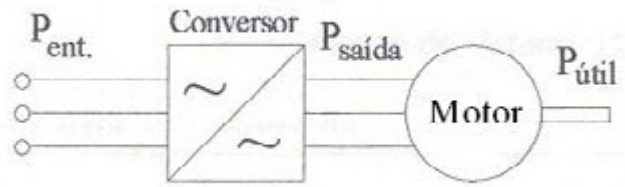

$$\left. \begin{array}{l} \eta_{conv} = P_2 / P_1 \\ \eta_{conv} = P_3 / P_2 \end{array} \right\} \eta_{sist} = P_{out} / P_{in} = P_3 / P_1 = \eta_{conv} \cdot \eta_{mot}$$

Some practical values found by means of the input-output measurement method are shown below for standard motors:

Motor 75 HP (55 kW) – 6 poles – 400 V – 50 Hz

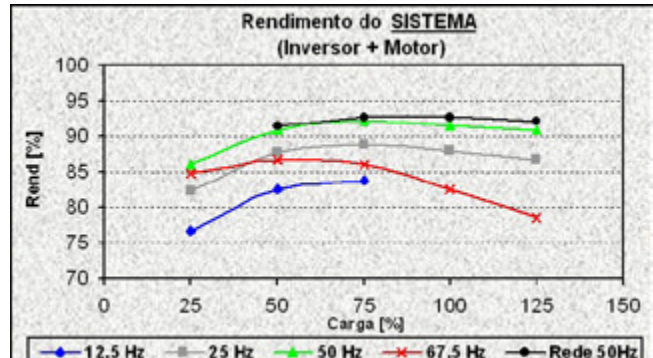

Motor 15 HP (11 kW) – 4 poles – 400 V – 50 Hz

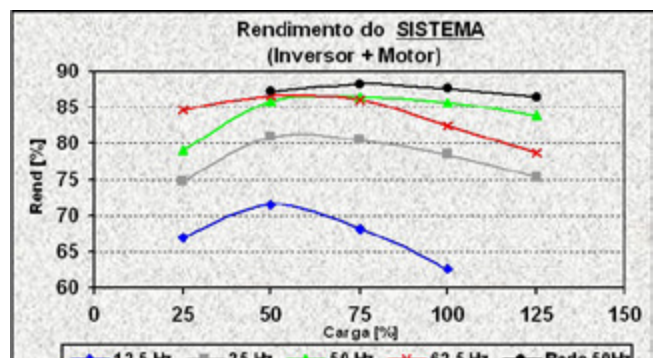

6.2.2 Normative considerations about the efficiency of inverter fed motors

- NEMA MG1 Part 30 – Efficiency will be reduced when a motor is operated on a bus with harmonic content. The harmonics present will increase the electrical losses which, in turn, decrease efficiency. This increase in losses will also result in an increase in motor temperature, which further reduces efficiency.

- NEMA MG1 Part 31 – Performance tests, when required, shall be conducted on a sinusoidal power supply unless otherwise specified by mutual agreement between the manufacturer and the user.
- NEMA Application Guide for AC ASD Systems – The overall efficiency of an ASD is based on the total losses of the control, the motor, and any auxiliary equipment. (...) The motor efficiency when operated on a control is slightly less than when operated on sinewave power. Overall system efficiency is often increased when used an ASD. Traditional methods of changing speed such as gears or belts introduce additional losses which reduce efficiency.
- IEC 60034-17 – The performance characteristics and operating data for drives with inverter-fed cage induction motors are influenced by the complete system, comprising supply system, inverter, induction motor, mechanical shafting and control equipment. Each of these components exists in numerous technical types. Any values quoted in this technical specification are thus indicative only. (...) There is no simple method to calculate the additional losses and no general statement can be made about their value. Their dependence upon the different physical quantities is very complex. Also there is a great variety both of inverters and of motors.
- IEC 60034-25 – The recommended methods to determine the motor efficiency are given in IEC 60034-2 (summation-of-losses method for motors > 150 kW and input-output measurement for motors ≤ 150 kW). The no-load losses (including the additional losses) should be measured at the same pulse pattern and pulse frequency that the inverter will produce at rated load. The determination of the overall efficiency of the system (motor + inverter) by means of input-output measurement for motors > 150 kW is also applicable under agreement between manufacturer and user. In this case, however, the motor efficiency shall not be determined separately.

6.3 Influence of the inverter on the temperature rise of the windings

Induction motors may heat up more when fed by frequency inverter than when fed by sinusoidal supply. This higher temperature rise results from the motor losses growth owing to the high frequency components of the PWM signal and the often reduced heat transfer resulting from speed variation.

The voltage harmonic distortion contributes to increase the motor losses, once that creates minor hysteretic loops in the lamination steel, increasing the effective saturation of the magnetic core and giving rise to high frequency harmonic currents, which bring about additional Joule losses.

Nevertheless, these high frequency components do not contribute to the production of torque at steady operation of the motor, since they do not increase the airgap fundamental flux, which rotates at synchronous speed. The operation at low speeds causes the ventilation over the (self-ventilated) motor frame to decrease, consequently lowering the motor cooling and raising in this way the thermal stabilization temperature.

Therefore, when operating with frequency inverters, both the effects mentioned above must be considered. There are basically the following solutions to avoid excessive overheating of the inverter fed motor:

- Torque derating (oversizing of the self ventilated motor frame);
- Utilization of independent cooling system (separate ventilation);
- Utilization of the “Optimal Flux Solution” (exclusive to applications using WEG drives and motors).

6.4 Criteria regarding the temperature rise of WEG motors on VSD applications

6.4.1 Torque derating

In order to keep the temperature rise of WEG motors, when under PWM supply, within acceptable levels, the following loadability limits must be attended (observe the **motor line and the flux condition**).

NOTE: Applications with motors rated for use in hazardous areas must be particularly evaluated - in such case please contact WEG.

6.4.1.1 NEMA market

TEFC W21 and W22 (High Efficiency) motors					
Frame Size	Constant Torque	Variable Torque	Constant Power	Drive	Comments
143 – 587(***)	12:1	1000:1	60 – 120 Hz	Any	Constant flux
	100:1(*)	-	60 – 120 Hz	WEG(**)	Optimal flux
587(****)	4:1	1000:1	60 – 120 Hz	Any	Constant flux
	10:1	-	60 – 120 Hz	WEG(**)	Optimal flux
TEFC NEMA PREMIUM EFFICIENCY motors					
Frame Size	Constant Torque	Variable Torque	Constant Power	Drive	Comments
143 – 587(***)	20:1	1000:1	60 – 120 Hz	Any	Constant flux
	1000:1(*)	-	60 – 120 Hz	WEG(**)	Optimal flux
587(****)	6:1	1000:1	60 – 120 Hz	Any	Constant flux
	12:1	-	60 – 120 Hz	WEG(**)	Optimal flux

(*)Satisfactory motor performance depends on proper drive setup – please contact WEG
 (**)WEG drive CFW-09 version 2.40 or higher, operating in sensorless (open loop) vector mode

(***)Motors with rated power ≤ 250 hp. Criteria also valid for motors of the frame sizes 447 and 449

(****)Motors with rated power > 250 hp. Criteria also valid for motors of the frame sizes 447 and 449

NOTE:

1. The speed ranges stated above are related to the motor thermal capability only. Speed regulation will depend on VFD mode of operation and proper adjustment.
2. W21 and NEMA PREMIUM EFFICIENCY WEG MOTORS of all frame sizes can also be blower cooled under request. In such case, the motor will be suitable for variable and constant torque applications rated up to 1000:1 with any drive.
3. W21 and NEMA PREMIUM EFFICIENCY WEG MOTORS comply with those maximum safe operating speeds established in NEMA MG1 Parts 30 and 31 (2003).

The relations set above describe operation speed ranges. Supposing for instance a 60 Hz base frequency, the following equivalence is valid:

Relation	Frequency range
4:1	15 – 60 Hz
10:1	6 – 60 Hz
12:1	5 – 60 Hz
20:1	3 – 60 Hz
100:1	0,6 – 60 Hz
1000:1	0,06 – 60 Hz

6.4.1.2 IEC market

Constant flux condition:

Encompassed motor lines: Totally enclosed off-the-shelf motors attending IE1 (as per IEC 60034-30) or higher efficiency levels.

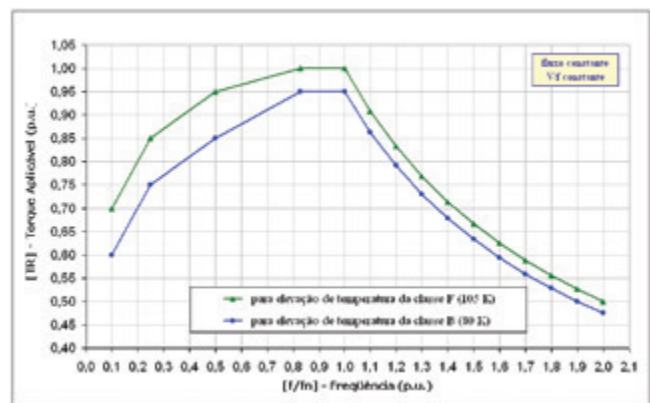

Optimal flux condition:

Encompassed motor lines: Totally enclosed off-the-shelf motors attending IE2 (as per IEC 60034-30) or higher efficiency levels.

The patented WEG “Optimal Flux” solution was developed for the purpose of making WEG induction motors able to operate at low speeds with constant torque loads still keeping an acceptable temperature rise level, without the need of neither oversizing the machine nor blower cooling it.

It is based on the continuous minimization of the motor

losses (heat sources) by means of the optimization of its magnetic flux, parameter controlled by the CFW09. From the study of the composition of the overall motor losses and their relation with the frequency, the magnetic flux and the current, as well as the influence of the ventilation system on the motor temperature rise, it was found an optimal flux value for each frequency, allowing for a continuous minimization of the overall motor losses through the whole speed range. The solution obtained was implemented within the CFW09, in order that the motor magnetic flux optimal condition can be achieved automatically by the drive, sufficing for that a simple adjustment of the inverter properly made.

The motor iron losses strongly depend on the frequency. As the operation frequency is varied downwards, the iron losses are gradually reduced. Therefore it is interesting at low speed operation to increase the magnetic induction (flux density) of the motor, so that the torque can be kept constant with a reduced current, which causes reduced Joule losses. Thus as the speed falls, it is possible to reduce the voltage proportionally less than the frequency, resulting in an optimal V/Hz ratio (greater than the rated value), which minimizes the motor losses altogether. It is considered thereby that the major motor losses occur due to Joule effect on the windings.

This solution was especially conceived for low speed applications with constant torque loads and must be used in no way with variable torque loads or above the motor base frequency. Besides, the Optimal Flux WEG solution is applicable only when:

- the motor is fed by WEG inverter (CFW09) version 2.40 or higher;
- sensorless vector type control is used.

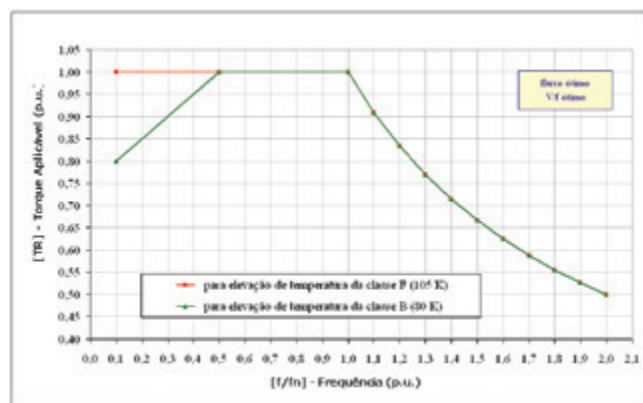

6.4.2 Breakaway torque

According to NEMA MG1 Parts 30 and 31, the motor should be capable of producing a breakaway torque of at least 140% of rated torque requiring not more than 150% rated current. WEG motors when fed by inverters attend such recommendation.

6.4.3 Breakdown torque

Above base speed the motor voltage must be kept constant for constant power operation, as already shown. NEMA MG1 Part 31 prescribes that the breakdown torque at any frequency within the defined frequency range shall be not less than 150% of the rated torque at that frequency when rated voltage for that frequency is applied. WEG motors when fed by inverters satisfy such criterion up to 90 Hz.

The maximum torque capability of the motor (breakdown torque) limits the maximum operating speed in which constant power operation is possible. Attending NEMA recommendations, one can approximately find this limit from the following equation:

$$RPM_{max} = \frac{2}{3} \left(\frac{T_{max}}{T_{base}} \right) RPM_{base}$$

6.5 Influence of the inverter on the insulation system

The evolution of the power semiconductors have led to the creation of more efficient, but also faster, electronic switches. The high switching frequencies of the IGBT transistors employed in modern frequency inverters bring about some undesirable effects, such as the increase of electromagnetic emission and the possibility of voltage peaks, as well as high dV/dt ratios (time derivative of the voltage, that is, rate of electrical potential rise), occurrence at the inverter fed motor terminals. Depending on the control characteristics (gate resistors, capacitors, command voltages, etc.) and the PWM adopted, when squirrel cage induction motors are fed by frequency inverters, those pulses combined with the impedances of both the cable and the motor may cause repetitive overvoltages on the motor terminals. This pulse train may degrade the motor insulation system and may hence reduce the motor lifetime.

The cable and the motor can be considered a resonant circuit, which is excited by the inverter rectangular pulses. When the values of R, L and C are such that the peak voltage exceeds the supply voltage ($V_{DC} \cong 1.41 V_{in}$), the circuit response to this excitation is a so called “overshoot”. The overshoots affect especially the interturn insulation of random windings and depend on several factors: **rise time of the voltage pulse, cable length and type, minimum time between successive pulses, switching frequency and multimotor operation.**

6.5.1 Rise Time

The PWM voltage takes some time to rise from its minimum to its maximum value. This period is often called “rise time”. Due to the great rapidity of switching on the inverter stage, the growth of the voltage wavefront takes place too fast and, with the power electronics advance, these transition times tend to be more and more reduced.

Then the inverter fed motor is subjected to extremely high dV/dt rates, so that the first turn of the first coil of a single phase is submitted to a high voltage level. Therefore variable speed drives can considerably increase the voltage stress within a

motor coil, though owing to the inductive and capacitive characteristics of the windings, the pulses are damped on the subsequent coils.

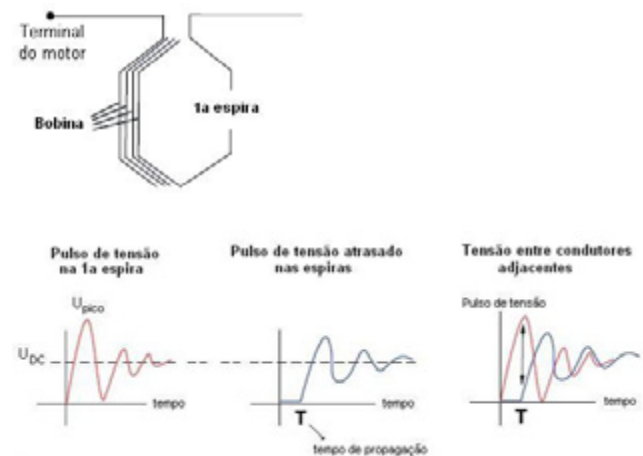

So the rise time (t_r) has a direct influence on the insulation life, because the faster the pulse wavefront grows, the greater the dV/dt ratio over the first coil and the higher the levels of voltage between turns, causing the insulation system to wear more quickly away. Thus the motor insulation system should present superior dielectric characteristics in order to stand the elevated voltage gradients occurring on PWM environment.

6.5.1.1 Normative considerations about rise time

The definitions of rise time (t_r) according to NEMA and to IEC Standards differ, as shown below, allowing for interpretation divergences and conflicts between manufacturers and users of motors and drives.

NEMA MG1 Part 30

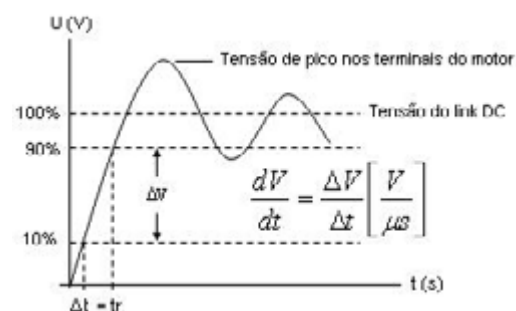

t_r : time needed for the voltage to rise from 10 to 90% of the DC link voltage ($\cong 1.41V_{rated}$)

NEMA definition of dV/dt

Supposing the motor voltage $V_{rated} = 460\text{ V}$
 $V_{link\ DC} \cong 1,41 \times 460 = 648,6\text{ V}$
 $\Delta V = 0,8 \times 648,6 = 518,9\text{ V}$

Assuming that rise time = $0,1\mu s$
 $\Delta t = 0,1\mu s$

$$\frac{dV}{dt} = \frac{\Delta V}{\Delta t} = \frac{518,9}{0,1} = 5189 \left[\frac{V}{\mu s} \right]$$

IEC 60034-25

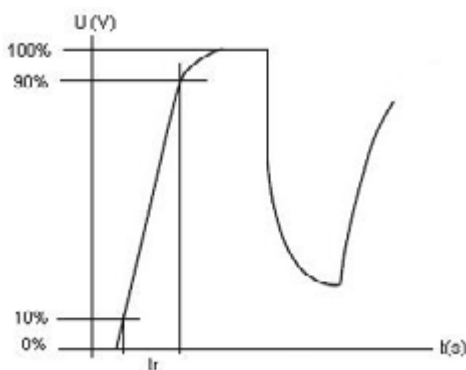

tr: time needed for the voltage to rise from 10% to 90% of the peak voltage at motor terminals

IEC definition of dV/dt

Supposing the motor voltage $V_{rated} = 460\text{ V}$
 with incidence of 1200 V peaks

$\Delta V = 0,8 \times 1200 = 960\text{ V}$

Assuming $tr = 0,25\mu s$:

$$\frac{dV}{dt} = \frac{\Delta V}{\Delta t} = \frac{960}{0,25} = 3840 \left[\frac{V}{\mu s} \right]$$

NOTE: Due to the cable, the rise time is higher at the motor terminals than at the inverter terminals. However, a very common mistake in the dV/dt calculation is to consider the rise time at the inverter terminals and the voltage peak at the motor terminals, resulting in an unlikely dV/dt value. For instance, considering $tr = 0,1\mu s$ (typical value found at the inverter) in the case above it would result $dV/dt = 9600\text{ V}/\mu s$!

Owing to the differences existing between the rise time definitions given by NEMA and IEC, misunderstandings often happen when calculating the voltage gradient (dV/dt).

According to NEMA criterion the DC link voltage ($\cong 1.41\text{ Vin}$) must be taken as 100% voltage reference for the determination of rise time and the calculation of dV/dt. According to IEC criterion, however, the peak voltage arriving at the motor terminals is what must be taken as 100% voltage reference. Due to the cable, the rise time to be considered in IEC criterion will be normally higher than the one considered in NEMA criterion (which is the value informed by the inverter manufacturer). Thus depending on the criteria considered throughout the calculations, pretty different values of dV/dt are likely to be attributed to the same situation.

The insulation criteria defined for WEG motors are based on NEMA, in order not to depend on the final customer installation. Furthermore the NEMA criterion seems appropriate for considering just the linear stretch of the curve to approximate the derivative ($dV/dt \cong \Delta V/\Delta t$). The IEC criterion considers the peak voltage at the motor terminals, something extremely complicated to be predicted or estimated a priori. The rise time at the motor terminals is increased by the cable high frequency impedance. The dV/dt ratio at the motor terminals (milder than at the drive terminals) can be also calculated, but it requires a reliable measurement of the voltage pulses at the motor leads and most of times this is not easily accomplished or not even feasible, demanding a technician familiar with such applications equipped with a good oscilloscope.

6.5.2 Cable length

Beside the rise time, the cable length is a predominant factor influencing the voltage peaks occurrence at the inverter fed motor terminals. The cable can be considered a transmission line with impedances distributed in sections of inductances/capacitances series/parallel connected. At each pulse, the inverter delivers energy to the cable, charging those reactive elements.

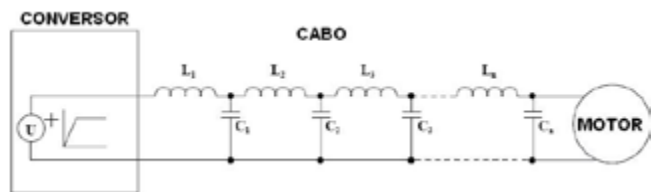

The signal arriving at the motor through the cable is partially reflected, causing overvoltage, because the motor high frequency impedance is greater than the cable impedance. Excessively long leads increase the overshoots at the motor terminals. According to the NEMA Application Guide for AC ASD Systems, with the modern IGBT controls overshoots begin to occur with a cable length of a few feet and can reach 2 times the control DC bus voltage at a length less than 50 feet. In some cases, however, very long cables (in excess of 400 feet, for example) can result in a situation where the overshoot does not decay quickly enough. In this case the voltage peak at the motor terminals can ring up well beyond 2 times the inverter DC link voltage. This behavior is a function of the PWM pulse pattern, the rise time and the very

cable type. Voltage measurements realized at the inverter terminals (0 ft cable) and at the motor ($V_{rated} = 400\text{ V}$) terminals with different cable lengths are presented next. The overshoots also depend on the type of cable used in the installation; therefore the waveforms shown below are illustrative only.

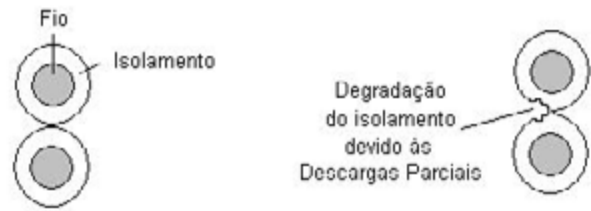

Converter terminals

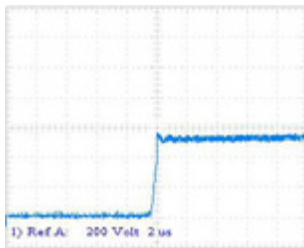

$V_{peak} = 560\text{ V}$

65.5 ft cable

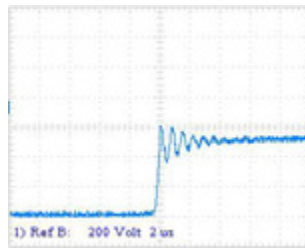

$V_{peak} = 630\text{ V}$

98.5 ft cable

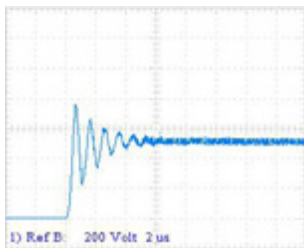

$V_{peak} = 750\text{ V}$

328 ft cable

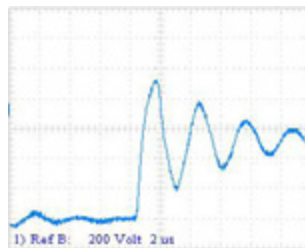

$V_{peak} = 990\text{ V}$

Partial discharge effect on the motor insulation system

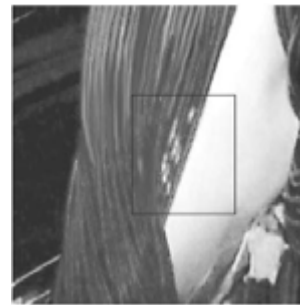

Damaged insulation due to PD activity

PD is thus a low energy discharge which, after long term activity, prematurely degrades the motor insulation. The erosion reduces the thickness of the insulating material, resulting in a progressive reduction of its dielectric properties, until its breakdown voltage capability falls below the level of the applied voltage peak, then the insulation breakdown occurs.

6.5.2.1 Corona effect

Depending on the quality/homogeneity of the impregnation the impregnating material may contain voids (cavities), in which the failure mechanism of the interturn insulation develops. The deterioration of the motor insulating system due to the voltage overshoots occurs by means of Partial Discharges (PD), a complex phenomenon resulting from Corona.

Between adjacent charged conductors there is relative voltage, which gives rise to an electric field. If the established electric field is high enough (but below the breakdown voltage of the insulating material), the dielectric strength of the air is disrupted, that is, if there is sufficient energy, oxygen (O_2) is ionized in ozone (O_3). The ozone is highly aggressive and attacks the organic components of the insulation system damaging it. For this to happen though the voltage on the conductors must exceed a threshold value, the so called "Corona Inception Voltage", that is the local breakdown strength in air (within the void). The CIV depends on the windings design, insulation type, temperature, superficial characteristics and moisture.

6.5.3 Minimum time between successive pulses (MTBP)

The voltage measurements presented above show that there is a succession of peaks in the voltage waveform delivered by the drive and arriving at the motor terminals. This signal propagates through the cable at a determined velocity. Depending on the winding characteristics and, with respect to the waveform, on the minimum time between successive pulses, the voltage appearing between turns may vary sensibly.

The average voltage applied at the motor terminals is controlled by the width of the pulses and by the time between them. The overshoots get worse with shorter times between pulses. This condition is most likely to occur at high peak or high output voltages and during transient conditions, such as acceleration or deceleration. If the time between pulses is less than three times the resonant period of the cable (typically 0.2 to 2 μs for industrial cable), then additional overshoot will occur. The only way to be sure that this condition does not exist is by measuring the pulses directly or by contacting the control manufacturer.

When the time between successive pulses is less than $6 \mu\text{s}$, particularly when the first and the last turns of a single coil of a random winding are side by side, it may be assumed that the voltage between adjacent conductors is the peak to peak value between pulses. This fact results from the rapidity of the pulse propagation within a coil, because while the first turn stands a peak to peak voltage value, the voltage on the last turn is very low, probably zero.

In the case of the example shown above the MTBP was below $6 \mu\text{s}$ and there were actually motor failures due to short circuit between turns.

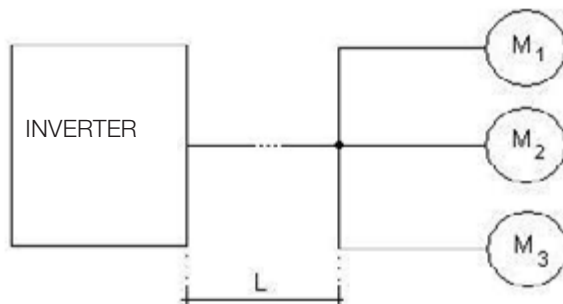
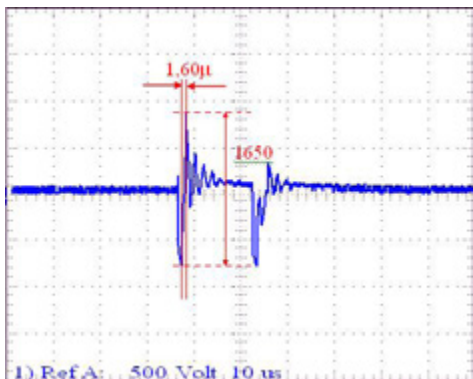

When connecting multiple motors to a single inverter, L must be as short as possible.

6.5.4 Switching frequency (f_s)

Beside the effects caused by the rise time and the MTBP, there is also the frequency at which they are generated. Differently from eventual impulses caused by line handles, it is about a pulse train supported at a certain frequency. Owing to the fast developments on power electronics, presently this frequency reaches easily values such as 20 kHz. The higher the switching frequency, the faster the degradation of the motor insulation takes place. Studies bear out that there is no simple interrelation between the insulation life and the switching frequency, in spite of that experiences have shown interesting data:

- If $f_s \leq 5 \text{ kHz}$ the probability of insulation failure occurrence is directly proportional to the switching frequency
- If $f_s > 5 \text{ kHz}$ the probability of insulation failure occurrence is quadratically proportional to the switching frequency.

High switching frequencies can cause bearing damages. On the other hand, switching frequency increase results in the motor voltage FFT improvement and so tends to improve the motor thermal performance besides reducing noise.

6.5.5 Multiple motors

If more than one motor is connected to a control, there can be additional overshoot due to reflections from each motor. The situation is made worse when there is a long length of lead between the control and the common connection of motors. This length of lead acts to decouple the motor from the control. As a result, reflections which would normally be absorbed by the low impedance of the control can be carried to another motor and add to the overshoot at its terminals.

6.6 Criteria regarding the insulation system of WEG motors on VSD applications

When WEG low voltage induction motors are used with inverters, the following criteria must be attended in order to protect the insulation system of the motor. If any of the conditions below are not satisfied, filters must be used.

NOTE: Applications with motors rated for use in hazardous areas must be particularly evaluated - in such case please contact WEG.

Motor rated voltage	Voltage Spikes motor terminals	dV/dt inverter terminals	Rise Time t_{do} inverter*	MTBP*
$V_{rated} < 460 \text{ V}$	$\leq 1600 \text{ V}$	$\leq 5200 \text{ V}/\mu\text{s}$	$\geq 0,1 \mu\text{s}$	$\geq 6 \mu\text{s}$
$460 \text{ V} \leq V_{rated} < 575 \text{ V}$	$\leq 2000 \text{ V}$	$\leq 6500 \text{ V}/\mu\text{s}$		
$575 \text{ V} \leq V_{rated} \leq 1000 \text{ V}$	$\leq 2400 \text{ V}$	$\leq 7800 \text{ V}/\mu\text{s}$		

* Informed by the inverter manufacturer

The maximum recommended switching frequency is 5 kHz.

Moisture is detrimental to insulating materials and therefore must be avoided for a longer motor life to be guaranteed. In order to keep the motor windings dry, it is recommended the use of heating resistors.

The insulation system to be used in each case depends on the motor rated voltage range and on the frame size.

6.7 Normative considerations about the insulation system of inverter fed motors

- **NEMA MG1** – if the voltage at the inverter input does not exceed the motor rated voltage and if the voltage observed at the motor terminals does not exceed the limits shown below, it may be assumed that there will be no voltage stress reducing significantly the life of the insulation system.

Nema MG1 - Part 30 General purpose motors	Nema MG1 - Part 31 Definite purpose inverter fed motors
$V_{rated} \leq 600 V : V_{peak} \leq 1kV$ Rise time $\geq 2\mu s$	$V_{rated} > 600 V : V_{peak} \leq 3,1 V_{rated}$ Rise time $\geq 0,1\mu s$
$V_{rated} \leq 600 V : V_{peak} \leq 2,04 V_{nom}$ Rise time $\geq 1\mu s$	$V_{rated} \leq 600 V : V_{peak} \leq 2,04 V_{rated}$ Rise time $\geq 1\mu s$

WEG motors fully attend NEMA MG1 Parts 30 and 31.

- **IEC 60034** – for motors up to 500 V the insulation system must stand voltage peak levels as shown below. For motors above 500 V, reinforced insulation systems must be applied or filters shall be installed at the inverter output, aiming to increase the rise time and to limit voltage peaks.

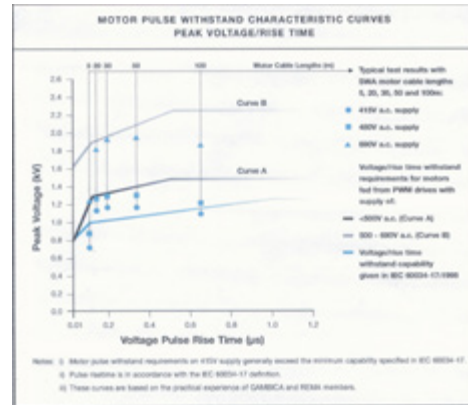

IEC 60034-17
General purpose motors

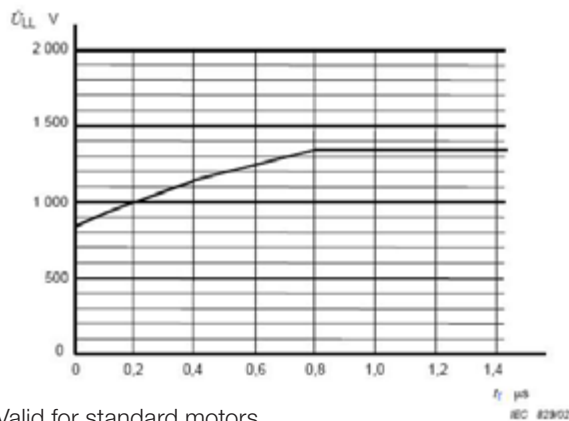

Valid for standard motors.

It is remarkable the similarities existing between IEC and GAMBICA criteria, as well as their disparity with respect to NEMA criteria. This results from the particular definitions of rise time and dV/dt according to each institution. One can notice that the insulation criteria from both IEC and GAMBICA take into account the cable length, information which WEG also considers relevant.

6.8 Recommendations for the cables connecting WEG motors to inverters

As already mentioned the maximum peak voltage appearing at the terminals of the inverter fed motor depends on many factors, predominantly the cable length.

When supplying WEG motors with inverters, the following practical rules are suggested for the evaluation of the need of using filters between motor and inverter.

Cable length L	Output filters
$L \leq 100 m$	Not needed
$100 m < L \leq 300 m$	Output reactor needed (at least 2% voltage drop)
$L > 300 m$	Special filters needed (contact WEG)

IEC 60034-25
Definite purpose motors

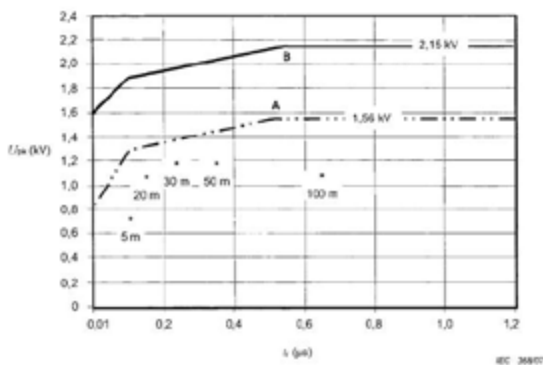

- A: Valid for motors up to 500 Vac (without filters)
- B: Valid for motors up to 690 Vac (without filters)
- C: Measured results at 415 Vac supply with different cable lengths

The output reactor is necessary for the eddy current that flows from inverter to earth to be limited. The input (line) reactor prevents the inverter ground fault from tripping.

The output reactor design must take account of additional losses occurring due to current ripple and current leakage to earth, which increases as cable length rises. For long cables and reactors designed for small currents there will be great influence of the leakage currents on the reactor losses (and heating). The cooling system of the inverter panel must also take the reactors additional losses into account for a safe temperature operation to be assured.

The output reactor must be installed near the inverter, as shown below.

- **GAMBICA/REMA** – the European association of motors (REMA) and inverters (GAMBICA) manufacturers set the criteria shown next based on its members' experience.

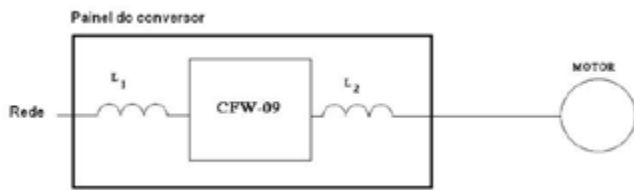

L1 = Line reactor – selection criteria according to clause 5.2
 L2 = Output reactor – must be installed next to the inverter.

6.8.1 Cable types and installation recommendations

The characteristics of the cable connecting motor and frequency inverter, as well as its interconnection and physical location, are extremely important to avoid electromagnetic interference in other devices.

6.8.1.1 Unshielded cables

- Three-core unshielded motor cables can be used when there is no need to fulfill the requirements of the European EMC Directives (89/336/EEC).
- Certain minimum distances between motor cables and other electrical cables must be observed in the final installation. These are defined in the table below.
- Emission from cables can be reduced if they are installed together on a metallic cable bridge which is bonded to the earthing system at least at both ends of the cable run. The magnetic fields from these cables may induce currents in nearby metalwork leading to heating and increasing losses.

6.8.1.2 Shielded cables

- They help to reduce the radiated emission through the motor cables in the Radio Frequency range (RF).
- They are necessary when the installation must comply with the EMC Directive 89/336/EEC as per EN 61800-3.
- They are also necessary when using Radio Frequency Interference Filter (whether built-in or external) at inverter input.
- Minimum distances between motor cables and other electrical cables (for instance, signal cables, sensor cables, etc.) must be observed in the final installation, as per table below.

Recommended separation distances between motor cable (shielded or not) and other cables of the installation	
Cable Length	Minimum separation distance
≤ 30 m	≥ 10 cm
> 30 m	≥ 25 cm

6.8.1.3 Installation recommendations

IEC 60034-25 presents cable types and construction details.

The basic given recommendations are summarized in the table below. For more details and updated information the current standard version shall be consulted.

The grounding system must be capable to provide good connections among equipments, for example, between motor and inverter frame. Voltage or impedance differences between earthing points can cause the flow of leakage currents (common mode currents) and electromagnetic interference.

Examples of shielded cables recommended by IEC 60034-25

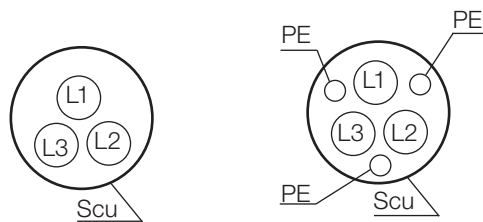

Alternate motor cables for conductors up to 10 mm²

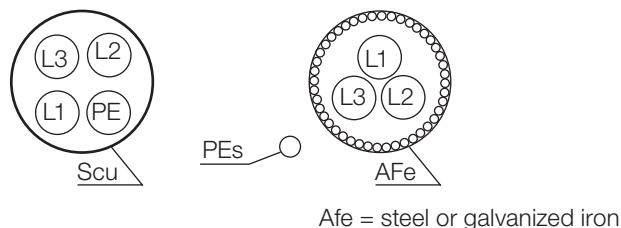

Symmetrical Shielded Cables: three-core cable (with or without conductors for protective earth) symmetrically constructed + a concentric copper or aluminum protective shield/armour

PE = protective earth conductor
 SCU = concentric copper (or aluminum) screen

Cable shield must be grounded at both ends, motor and inverter. Good EMC practices such as 360° bonding of the shields are recommended, in order for low impedance for high frequency to be provided.

For the shield to operate also as protective conductor, it should have at least 50% of the phase conductors' conductance. If the shield does not have enough cross-section for that, then a separate earth conductor is needed and the shield provides EMC and physical protection only. The shield high-frequency conductance should be at least 10% of that of the phase conductors.

6.9 Influence of the inverter on the motor shaft voltage and bearing currents

The advent of static inverters aggravated the phenomenon of induced shaft voltage/current, due to the unbalanced waveform and the high frequency components of the voltage supplied to the motor. The causes of shaft induced voltage owing to the PWM supply is thus added to those intrinsic to

the motor (for instance, electromagnetic unbalance caused by asymmetries), which as well provoke current circulation through the bearings. The basic reason for bearing currents to occur within an inverter fed motor is the so called common mode voltage. The motor capacitive impedances become low in face of the high frequencies produced within the inverter stage of the inverter, causing current circulation through the path formed by rotor, shaft and bearings back to earth.

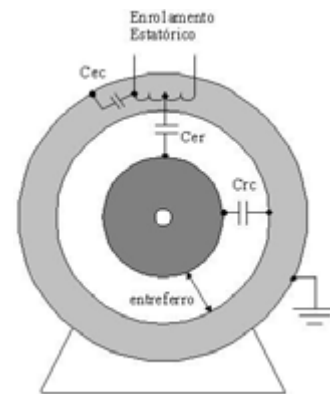

6.9.1 Common mode voltage

The three phase voltage supplied by the PWM inverter, differently from a purely sinusoidal voltage, is not balanced. That is, owing to the inverter stage topology, the vector sum of the instantaneous voltages of the three phases at the inverter output does not cancel out, but results in a high frequency electric potential relative to a common reference value (usually the earth or the negative bus of the DC link), hence the denomination “common mode”.

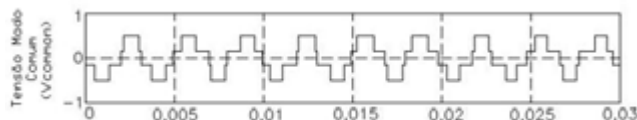

The sum of the instantaneous voltage values at the (three phase) inverter output does not equal to zero

This high frequency common mode voltage may result in undesirable common mode currents. Existing stray capacitances between motor and earth thus may allow current flowing to the earth, passing through rotor, shaft and bearings and reaching the end shield (earthed).

Practical experience shows that higher switching frequencies tend to increase common mode voltages and currents.

6.9.2 Equivalent circuit of the motor for the high frequency capacitive currents

The high frequency model of the motor equivalent circuit, in which the bearings are represented by capacitances, shows the paths through which the common mode currents flow.

The rotor is supported by the bearings under a layer of non-conductive grease. At high speed operation there is no contact between the rotor and the (earthed) outer bearing raceway, due to the plain distribution of the grease. The electric potential of the rotor may then rise with respect to the earth until the dielectric strength of the grease film is disrupted, occurring voltage sparking and flow of discharge current through the bearings. This current that circulates whenever the grease film is momentarily broken down is often referred to as the capacitive discharge component. There is still another current component, which is induced by a ring flux in the stator yoke and circulates permanently through the characteristic conducting loop comprising the shaft, the end shields and the housing/frame, that is often called the conduction component.

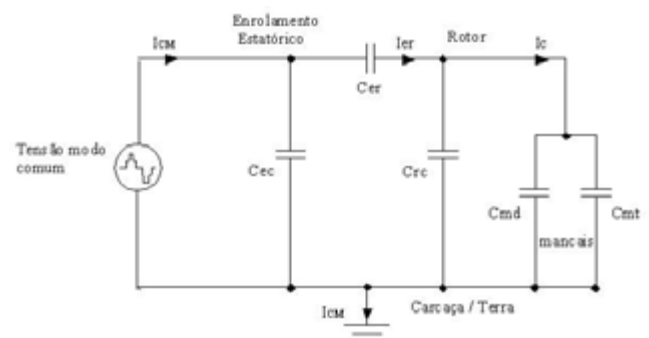

C_{er} : Capacitor formed by the stator winding and the rotor lamination (Dielectric = airgap + slot insulation + wire insulation)

C_{rc} : Capacitor formed by the rotor and the stator cores (Dielectric = airgap)

C_{ec} : Capacitor formed by the stator winding and the frame (Dielectric = slot insulation + wire insulation)

C_{md} e C_{mt} : Capacitances of the DE (drive end) and the NDE (non-drive end) bearings, formed by the inner and the outer bearing raceways, with the metallic rolling elements in the inside. (Dielectric = gaps between the raceways and the rolling elements + bearing grease)

I_{CM} : Total common mode current

I_{er} : Capacitive discharge current flowing from the stator to the rotor

I_c : Capacitive discharge current flowing through the bearings

These discontinuous electric discharges wear the raceways and erode the rolling elements of the bearings, causing small superimposing punctures. Long term flowing discharge currents result in furrows (fluting), which reduce bearings life and may cause the machine to fail precociously.



Crater occasioned by electroerosion on the inner raceway of the bearing

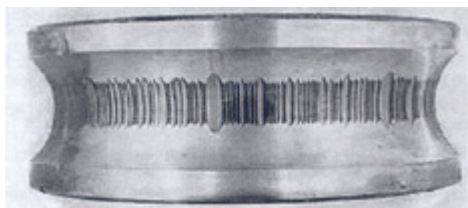

Bearing raceway damaged by bearing currents flow

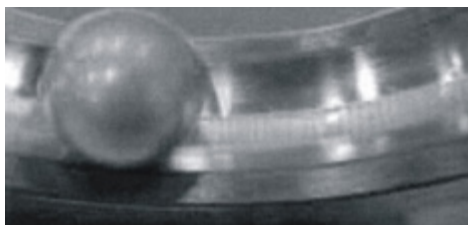

Fluting caused by electric discharges within the bearing

6.9.3 Methods to reduce (or mitigate) the bearings currents in inverter fed motors

For the motor bearing currents to be impeded to circulate, both the conduction (induced on the shaft) and the capacitive discharge (resultant from common mode voltage) components must be taken into account. In order to eliminate the current flowing through the characteristic conducting loop it is enough to isolate the motor bearings (only one of them, in the case of a single drive end, or the both of them, in the case of two drive ends). However, for the capacitive components to be withdrawn it would be also necessary to isolate the bearings of the driven machine, in order to avoid the migration of electric charges from the motor to the rotor of the driven machine through their shafts, which are electrically connected in the case of direct coupling. Another way of extinguishing the capacitive discharge current component consists of short circuiting the rotor and the motor frame by means of a sliding graphite brush. This way, the inductive current component flowing through the characteristic conducting loop can be eliminated by insulating just a single bearing of the motor, while the capacitive current component, as well as the transfer of capacitive charges to the driven machine, can be eliminated by use of a short circuiting brush.

Motor with one drive end

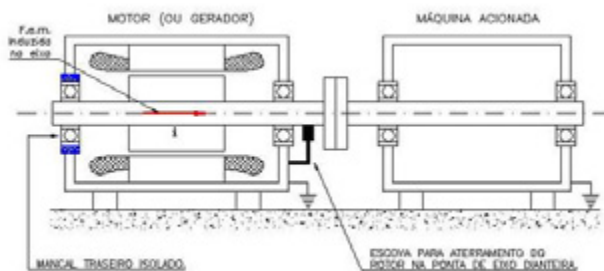

Without bearing protection:

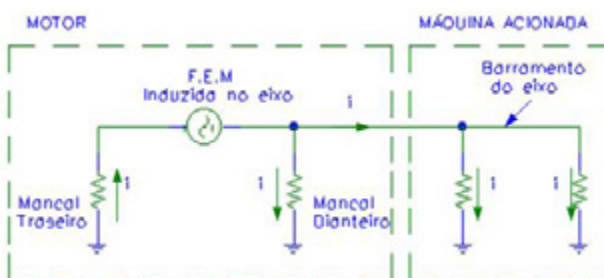

With protected bearing:

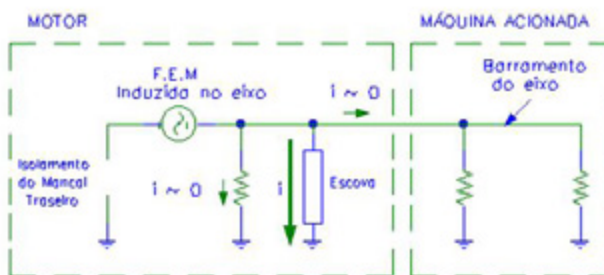

Motor with two drive ends

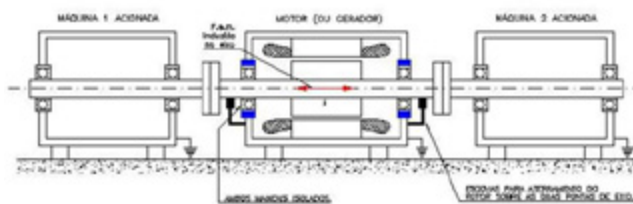

Without bearing protection:

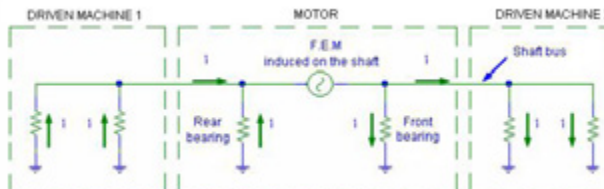

With bearing protection:

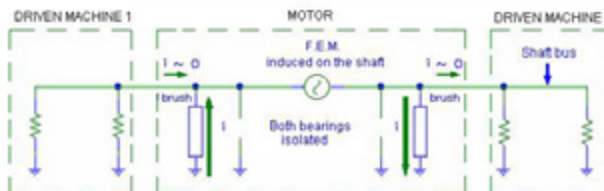

6.10 Criteria regarding protection against bearing currents (shaft voltage) of WEG motors on VSD applications

Platform	Frame Size	Standard	Optional
W21 W22	mod < 315 IEC mod < 504 NEMA	No protection	Please contact WEG
W21 W22	315 and 355 IEC 504/5 and 586/7 NEMA	No protection *	Insulated bearing in any or both motor ends Earthing system with slip ring and graphite brush between frame and shaft
HGF	315 ≤ mod ≤ 630 (IEC) 500 ≤ mod ≤ 1040 (NEMA)	Insulated NDE bearing Earthing system with slip ring and graphite brush between frame and shaft	Insulated DE bearing
M	280 ≤ mod ≤ 1800 (IEC) 440 ≤ mod ≤ 2800 (NEMA)	Insulated NDE bearing Earthing system with slip ring and graphite brush between frame and shaft	Insulated DE bearing

* For Inverter Duty line motors, the earthing system is standard.

NOTE: Applications with motors rated for use in hazardous areas must be particularly evaluated - in such case please contact WEG.

6.11 Normative considerations about the current flowing through the bearings of inverter fed motors

- NEMA MG1 Part 31 – with sinusoidal supply shaft voltages may be present usually in motors of frame 500 and larger. (...) More recently, for some inverter types and application methods, potentially destructive bearing currents have occasionally occurred in much smaller motors. (...) The current path could be through either or both bearings to ground. Interruption of this current therefore requires insulating both bearings. Alternately, shaft grounding brushes may be used to divert the current around the bearing. It should be noted that insulating the motor bearings will not prevent the damage of other shaft connected equipment.
- NEMA Application Guide for AC ASD Systems – the circulating currents caused by common mode voltage may cause bearing problems in frame sizes smaller than 500 (most likely in the 400 and larger frames).
- IEC 60034-17 – for machines with frame numbers above 315 it is recommended either to use an inverter with a filter designed to reduce the zero-sequence component of the phase voltages (so called common mode voltages) or to reduce the dV/dt of the voltage or to insulate the motor bearing(s). The need to insulate both motor bearings is seldom necessary. In such a case, the examination of the whole drive system by an expert is highly recommended and should include the driven machine (insulation of the coupling) and the grounding system (possibly use of an earthing brush).

- IEC 60034-25 – do not specify a minimum frame size on which bearing protection must be applied. Within the clause broaching the effects of magnetic asymmetries as shaft voltages/bearing currents cause, it is mentioned that bearing currents commonly occur in motors above 440 kW. For other causes, no mention is made concerning frame sizes. According to the document, the solution adopted to avoid bearing currents depends on which current component is to be avoided. It may be made either by means of insulated bearings or shaft grounding system though.
- CSA 22.2 N°100 Item 12 – shaft earthing brushes must be used in motors of frame above IEC 280 (NEMA 440).
- Gambica/REMA Technical Guide – for motors of frames below IEC 280 the effects of bearing currents are seldom appreciable and therefore no extra protection is needed. In such cases, adhering strictly to the motor and drive manufacturers' recommendations regarding the installation, cabling and grounding is enough. For frames above IEC 280, the effects of bearing currents may be significant and for security special protection is advisable. This may be obtained by means of insulated NDE bearing and shaft grounding system use. In such case, care must be taken not to bypass the bearing insulation.

6.12 Influence of the inverter on the motor acoustic noise

The rotating electrical machines have basically three noise sources:

- The ventilation system
- The rolling bearings
- Electromagnetic excitation

Bearings in perfect conditions produce practically despicable noise, in comparison with other sources of the noise emitted by the motor.

In motors fed by sinusoidal supply, especially those with reduced pole numbers (higher speeds), the main source of noise is the ventilation system. On the other hand, in motors of higher polarities and lower operation speeds often stands out the electromagnetic noise.

However, in variable speed drive systems, especially at low operating speeds when ventilation is reduced, the electromagnetically excited noise can be the main source of noise whatever the motor polarity, owing to the harmonic content of the voltage.

Higher switching frequencies tend to reduce the magnetically excited noise of the motor.

6.13 Criteria regarding the noise emitted by WEG motors on VSD applications

Results of laboratory tests (4 point measurements accomplished in semi-anechoic acoustic chamber with the inverter out of the room) realized with several motors and inverters using different switching frequencies have shown that the three phase induction WEG motors, when fed by frequency inverters and operating at base speed (typically 50 or 60 Hz), present and increment on the sound pressure level of 11 dB(A) at most.

6.14 Normative considerations about the noise of inverter fed motors

- NEMA MG1 Part 30 – the sound level is dependent upon the construction of the motor, the number of poles, the pulse pattern and pulse frequency, and the fundamental frequency and resulting speed of the motor. The response frequencies of the driven equipment should also be considered. Sound levels produced thus will be higher than published values when operated above rated speed. At certain frequencies mechanical resonance or magnetic noise may cause a significant increase in sound levels, while a change in frequency and/or voltage may reduce the sound level. Experience has shown that (...) an increase of up to 5 to 15 dB(A) can occur at rated frequency in the case when motors are used with PWM controls. For other frequencies the noise levels may be higher.
- IEC 60034-17 – due to harmonics the excitation mechanism for magnetic noise becomes more complex than for operation on a sinusoidal supply. (...) In particular, resonance may occur at some points in the speed range. (...) According to experience the increase at constant flux is likely to be in the range 1 to 15 dB(A).
- IEC 60034-25 – the inverter and its function creates three variables which directly affect emitted noise: changes in rotational speed, which influence bearings and lubrication, ventilation and any other features that are affected by temperature changes; motor power supply frequency and harmonic content which have a large effect on the magnetic noise excited in the stator core and, to a lesser extent, on the bearing noise; and torsional oscillations due to the interaction of waves of different frequencies of the magnetic field in the motor airgap. (...) The increment of noise of motors supplied from PWM controlled inverters compared with the same motor supplied from a sinusoidal supply is relatively small (a few dB(A) only) when the switching frequency is above about 3 kHz. For lower switching frequencies, the noise increase may be tremendous (up to 15 dB(A) by experience). In some circumstances, it may be necessary to create “skip bands” in the operating speed range in order to avoid specific resonance conditions due to the fundamental frequency.

6.15 Influence of the inverter on the mechanical vibration of the motor

Interactions between currents and flux harmonics may result in stray forces actuating over the motor causing mechanical vibration and further contributing to increase the overall noise levels. This mechanism gains importance especially when amplified by mechanical resonances within the motor or the driven machine. If any of the non-fundamental harmonics is near the natural frequencies of the motor, the forces produced can excite vibration modes.

Such effects can be attenuated with a careful design of the motor with respect to the stator and rotor slots, lamination and frame, always looking out for simplifying the mechanical system thus reducing the possibility of exciting natural frequencies that develops modes of vibration within the motor.

Modern frequency inverters are also provided with tools to

get those problems around, so that for instance specific frequencies within the operating range can be skipped and the acceleration/deceleration times can be conveniently adjusted.

6.16 Criteria regarding the vibration levels presented by WEG motors on VSD applications

Tests realized with several motors and inverters following the procedures recommended by IEC 60034-14 confirmed that the vibration levels of induction motors increase when these are fed by frequency inverters.

Furthermore, the observed increment on vibration speeds generally were lower with higher switching frequencies, that is, switching frequency increases tend to reduce the mechanical vibration of the inverter fed motor.

In any case, even when operating above the base speed, WEG motors presented RMS vibration velocity values (mm/s) below the maximum limits established by both the IEC 60034-14 and the NEMA MG1 Part 7 standards, thus attending the criteria required.

6.17 Normative considerations about mechanical vibration of inverter fed motors

- NEMA MG1 Part 30 – When an induction motor is operated from a control, torque ripple at various frequencies may exist over the operating speed range. (...) It is of particular importance that the equipment not be operated longer than momentarily at a speed where a resonant condition exists between the torsional system and the electrical system (i.e., the motor electrical torque). (...) It also is possible that some speeds within the operating range may correspond to the natural mechanical frequencies of the load or support structure and operation other than momentarily could be damaging to the motor and or load and should be avoided at those speeds.
- NEMA MG1 Part 31 – Machine sound and vibration are influenced by the following parameters: electromagnetic design; type of inverter; resonance of frame structure and enclosure; integrity, mass and configuration of the base mounting structure; reflection of sound and vibration originating in or at the load and shaft coupling; windage. It is recognized that it is a goal that motors applied on inverter type supply systems for variable speed service should be designed and applied to optimize the reduction of sound and vibration in accordance with the precepts explained above. However, since many of these influencing factors are outside of the motor itself, it is not possible to address all sound and vibration concerns through the design of the motor alone.
- IEC 60034-17 – The asynchronous (time-constant) torques generated by harmonics have little effect on the operation of the drive. However, this does not apply to the oscillating torques, which produce torsional vibrations in the mechanical system. (...) In drives with pulse-controlled inverters, the frequencies of the dominant oscillating torques are determined by the pulse frequency while their amplitudes depend on the pulse width. (...) With higher

pulse frequencies (in the order of 21 times the fundamental frequency) the oscillating torques of frequencies $6 \times f_1$ and $12 \times f_1$ are practically negligible, provided a suitable pulse pattern is applied (e.g. modulation with a sinusoidal reference wave or space-phasor modulation). Additionally, oscillating torque of twice the pulse frequency are generated. These, however, do not exert detrimental effects on the drive system since their frequency is far above the critical mechanical frequencies.

- IEC 60034-25 – If the inverter have appropriate output characteristics and if due care is taken with respect to the mechanical characteristics and the mounting of the motor, vibration levels similar to those resulting from sinusoidal environment will be produced. Therefore, there is no need for defining vibration criteria different from those already established in IEC 60034-14 for sinusoidal supply. Vibration levels measured with decoupled motors are indicative of the motor quality only, but in measurements accomplished at the actual application (with the motor finally installed) rather different values of vibration levels may be obtained.

- Torque varies at a rate proportional to the square of the speed
- Horsepower varies as the cube of the speed
- 100% load torque and horsepower at base speed

Linear torque variation

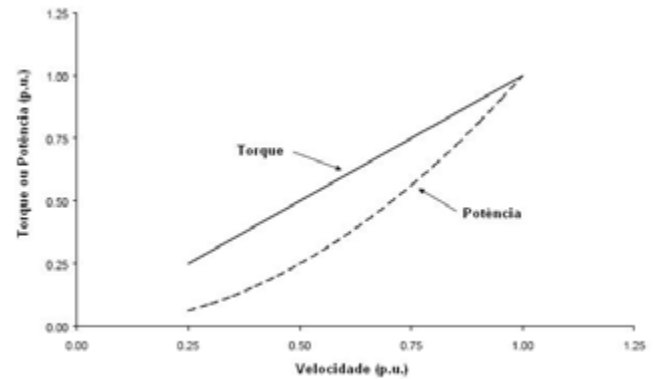

- Torque varies linearly with speed
- Horsepower varies as the square of the speed
- 100% load torque and horsepower at base speed

7 Interaction between motor and driven load

7.1 Load types

The correct dimensioning of the variable speed drive system depends on the knowledge of the behavior of the load, that is, how the load is related with speed and consequently how much torque is demanded on the motor shaft. In most processes the load may be described by one of the following terms: variable torque, constant torque and constant horsepower.

7.1.1 Typical examples:

Typical examples:

- Centrifugal pumps
- Centrifugal fans
- Centrifugal blowers
- Centrifugal compressors

Variable torque loads are good candidates to apply VSDs for energy savings, once that the mechanical power available at the motor output will not be constant - it will actually vary suitably in accordance with the load demand, as shown before in Clause 3 of this technical guide.

Squared torque variation

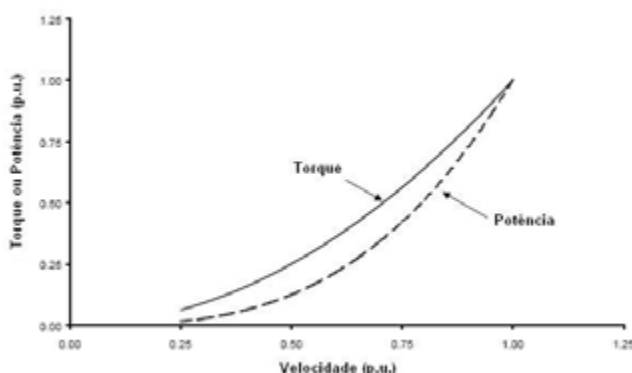

7.1.2 Constant torque loads

Typical examples:

- Screw compressors
- Reciprocating compressors
- Positive displacement pumps
- Extruders
- Crushers
- Ball mills
- Conveyors
- Augers
- Process lines (strip, web, sheet)

Machines that are high impact loads (intermittent torque loading not as function of speed, requiring that the motor and control combination produce sufficient accelerating torque to return the load to the required speed prior to the beginning of the next work stroke) or duty cycle loads (discrete loads - at changing or constant speeds - applied for defined periods of time repeated periodically) typically fall into the constant torque classification.

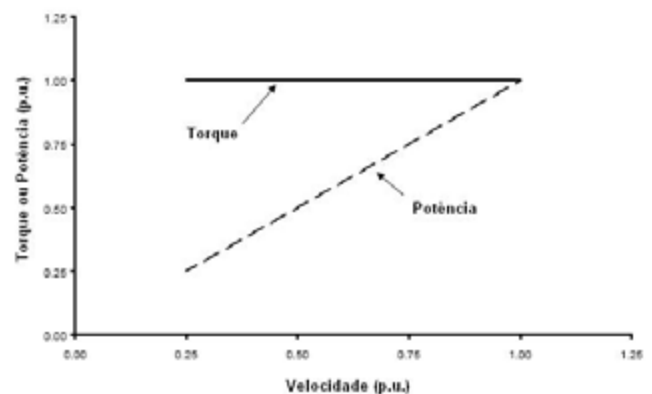

- Load torque remains constant throughout the speed range
- Horsepower changes linearly with operation speed
- Rated load torque and horsepower at base speed

7.1.3 Constant horsepower loads

Typical examples:

- Machine tools (where heavier cuts are taken at lower speeds and lighter cuts at higher speeds)
- Center driven winders

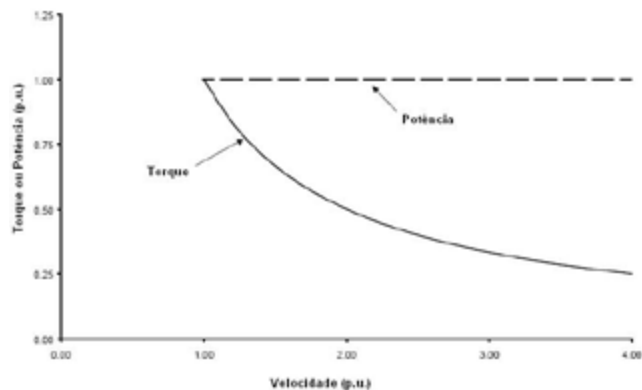

- Load torque drops as speed increases
- Horsepower results constant throughout the speed range
- Rated load torque and horsepower at base speed

7.2 Speed duties

7.2.1 Variable speed duty

Motors designated for variable speed duty are intended for varied operation over the defined speed range marked on the motor and is not intended for continuous operation at a single or limited number of speeds. The motor design takes the advantage of the fact that it will operate at a lower temperature at the load levels for some speeds than at other over the duty cycle.

7.2.2 Continuous speed duty

Motors designated for continuous speed duty can be operated continuously at any speed within the defined speed range. The motor is designed on the principle that it may be operated at its load level at the speed which results in the highest temperature rise for an indefinite period of time.

8 Dimensioning and analysis of actual drive system applications – Practical examples

8.1 Constant torque application - compressor

8.1.1 Example

Please dimension a WEG standard squirrel cage induction motor (TEFC) to operate with any WEG frequency inverter from 180 to 1800 rpm, driving a compressor demanding 34 Nm of torque. Temperature rise of thermal class B (80 K) wanted.

General data:

- Mains: 3-phase / 400 V / 60 Hz
- Environment: maximum temperature 40°C; altitude 1000 m; normal atmosphere
- Frequency inverter CFW-09: tr = 0,1 µs; fchav = 5 kHz

8.1.2 Solution

8.1.2.1 Regarding the temperature rise on the windings (derating torque)

Compressors are loads that feature a constant torque demand along the whole speed range. **The motor must be dimensioned to cope with the most critical operation condition, in this example the lowest speed within the operating range**, in which the ventilation is reduced to its minimum while the torque demand remains constant.

Considering that the operation speed may change from 180 to 1800 rpm and that the base frequency is 60 Hz, then a 4-pole motor must be chosen.

Neglecting the slip, the demanded horsepower at the base point of operation is:

$$T_L (kgfm) = \frac{960P(kW)}{n(rpm)} \Rightarrow P = \left(\frac{34}{9.81} \right) \frac{1800}{960} = 6.5 kW$$

Nevertheless, from the thermal point of view the worst working point of this self-ventilated motor is 180 rpm (6 Hz), which means the lowest speed and therefore the lowest effectiveness of the cooling system of the motor within the defined speed range. For this reason the torque derating must be calculated for this very condition.

According to the WEG derating criteria (subclause 6.4.1.2), when operating at 6 Hz a torque reduction of 40% results in a temperature rise of 80 oC on the motor windings.

Furthermore it must be assumed constant V/f condition, because it is asked that the motor be able to operate with any WEG drive (for the optimal flux solution to be applicable, a WEG high efficiency motor must be driven by a WEG inverter model CFW-09 version 2.40 or higher).

$$f = 6 \text{ Hz} \Rightarrow f/f_n = 6/60 = 0,10 \text{ per unit}$$

$$f/f_n = 0,10 \text{ p.u.} \Rightarrow Tr = 0,6 \text{ per unit}$$

That is, at 180 rpm the motor will be able to supply only 60% of its rated torque. Once the load demands constant torque (equal to the torque demanded at base speed) throughout the operating range, the motor must be oversized in accordance with the derating calculated.

$$T = \frac{T_L}{Tr} = \frac{34}{0,6} = 56.7 Nm$$

Thus the motor rated horsepower will be:

$$P = \left(\frac{56.7}{9.81} \right) \frac{1800}{960} = 10.83 kW$$

Consulting the WEG motors catalog, the ideal motor for this application is the 11 kW (15 hp) - 4 pole - 60 Hz - frame IEC 132M (NEMA 215 T).

The use of forced cooling system would be an alternative option. In this case, motor oversizing is not needed and a motor rated 7,5 kW (10 hp) – 4 pole (frame IEC 132S/NEMA 213T) would satisfactorily attend the application needs.

This way it is assured that the temperature rise of the motor will be equal to or less than 80 K at any operation condition.

8.1.2.2 Regarding the insulation system

According to NEMA criteria the situation is the following:

Voltage at the motor terminals:

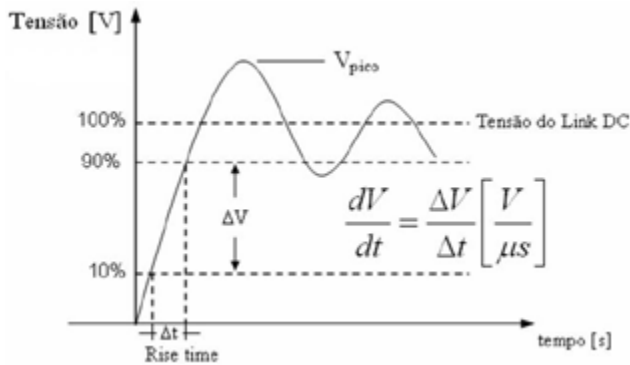

According to WEG insulation criteria (clause 6.6), WEG motors rated 400 V are able to stand:

- dV/dt values up to $5200 \text{ V}/\mu\text{s}$ at the drive terminals, thus satisfying the needs of this example.
- $tr \geq 0.1 \mu\text{s}$ at the inverter terminals, thus attending this example's application.
- $V_{\text{peak}} \leq 1430 \text{ V}$ at the motor terminals. If this condition is not attended at the definitive installation, filters must be connected to the inverter output.

The switching frequency defined for this example (5 kHz) is in agreement with WEG recommendations too. Therefore the motor designed fully attend this application's demands with regard to the insulation system.

However, it will not be possible to evaluate the matter on the point of view of IEC, because it requires the measurement of the voltage at the motor terminals. As the VSD system is still at the dimensioning stage and there is no actual motor at the application, it is understood that the final motor environment is still not defined, so that measures are made unfeasible and the actual voltage peak and rise time values at the motor terminals are unknown. Such values will depend on type and length of the cable employed at the end user.

8.1.2.3 Regarding the bearings' protection

According to WEG criteria regarding protection against bearing currents (clause 6.9), WEG standard motors have optional protected bearings for frames above (including) 315 IEC / 504 NEMA. The selected motor frame is 132 M IEC / 215 T NEMA, thus not needing shaft earthing system neither special insulated bearings.

8.1.2.4 Regarding the noise

When fed by inverter, the acoustic noise produced by the motor may increase up to 11 dB(A), considering that scalar control type will be used.

8.2 Squared torque application - centrifugal pump

8.2.1 Example

Please dimension an induction motor WEG NEMA Premium Efficiency (TEFC) to operate with a CFW-09 on vector control, driving a centrifugal pump rated 10 hp (7.5 kW) at maximum speed 2700 rpm.

General information:

- Power line: 3 phase / 460 V / 60 Hz
- Environment: maximum temperature 40°C ; altitude 1000 m; normal atmosphere
- WEG frequency inverter CFW-09: $tr = 0.1 \mu\text{s}$; $f_{\text{chav}} = 2.5 \text{ kHz}$

8.2.2 Solution

8.2.2.1 Regarding the temperature rise (derating torque)

Centrifugal pumps present a torque that characteristically varies at a rate proportional to the square of the speed, while the horsepower varies as the cube of the speed. In this case, **the motor must be dimensioned for the highest speed within the operation range of the pump**, because the maximum torque demand for the motor happens there.

The figure next shows that this example allows two alternatives for the dimensioning: a 2-pole motor or else a 4-pole motor. The 2-pole motor would operate at the constant torque region (below base speed), while the 4-pole motor would operate at field weakening region (above base speed).

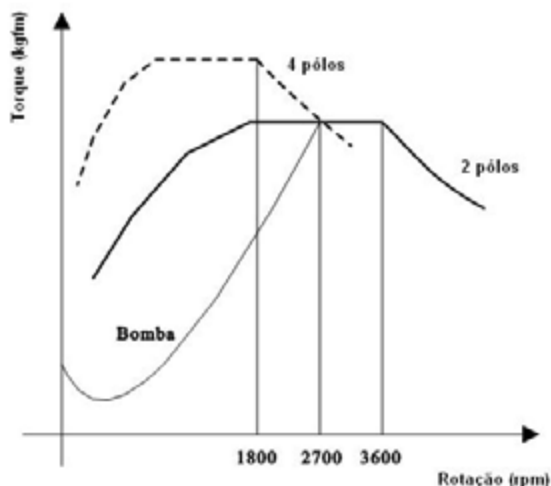

The torque required by the pump at maximum speed is given below:

$$T \text{ (kgfm)} = \frac{716P \text{ (hp)}}{n \text{ (rpm)}} \Rightarrow T_b = \frac{716 (10)}{2700} = 2,65 \text{ kgfm} = 25.99 \text{ Nm}$$

2-pole motor

$$2700 \text{ rpm} = 0.75 \text{ p.u.} \Rightarrow 45 \text{ Hz}$$

According to the derating criteria of WEG NEMA Premium Efficiency TEFC motors (subclause 6.4.1.1), any WEG NPE motor is able to operate 1000:1 with variable torque loads, that is, no torque derating is needed throughout the speed range. Then the derating factor will be 1.

$$T_{2p} = \left(\frac{T_b}{df} \right) \frac{25.99 \text{ Nm}}{1} = 19.17 \text{ lbft}$$

Consulting the WEG NEMA Motor Catalog, the most appropriate 3 phase IP55 motor is the NEMA Premium Efficiency 15 hp (11 kW) – 2 poles – 60 Hz – frame 254 T.

4-pole motor

$$2700 \text{ rpm} = 1.50 \text{ p.u.} \Rightarrow 90 \text{ Hz}$$

According to the derating criteria of WEG NEMA Premium Efficiency TEFC motors (subclause 6.4.1.1), any WEG NPE motor is able to support constant horsepower from 60 to 90 Hz with variable torque loads. Then at 90 Hz the derating factor will be (1.5)⁻¹.

$$T_{4p} = \left(\frac{T_b}{df} \right) = \frac{25.99 \text{ Nm}}{\frac{1}{1.5}} = 38.99 \text{ Nm} = 28.75 \text{ lbft}$$

Owing to the operation in the weakening field region, the motor breakdown torque must be also verified. According to the WEG motors' breakdown torque criteria (subclause 6.4.3), the motor is able to attend the application needs. Consulting the WEG NEMA Motor Catalog, the most appropriate 3 phase IP55 NEMA Premium Efficiency motor is the 10 hp (7.5 kW) – 4 poles – 60 Hz – frame 215 T.

Therefore, after both technical and economical analyses, the most suitable motor for this application turns out to be the 4-pole / 7.5 kW (10 hp) / 60 Hz / 460 V / frame 215T NEMA Premium Efficiency.

8.2.2.2 Regarding the insulation system

According to NEMA criteria the situation is the following:

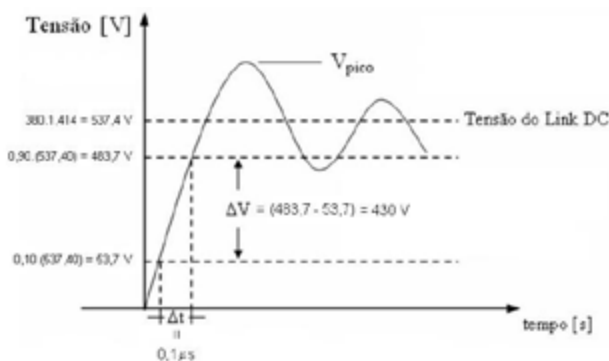

$$\frac{dV}{dt} = \frac{\Delta V}{\Delta t} = \frac{520.45 \text{ V}}{0.1 \mu\text{s}} \cong 5200 \text{ V}/\mu\text{s}$$

According to WEG insulation criteria (clause 6.6), WEG motors rated 460 V are able to bear:

- dV/dt values up to 5200 V/μs at the drive terminals, thus satisfying the needs of the application of this example.
- tr ≥ 0,1μs at the inverter terminals, thus attending this example's application.
- Vpeak ≤ 1430 V at the motor terminals. If this condition is not attended at the definitive installation, filters must be connected to the inverter output.

WEG recommends that switching frequencies up to 5 kHz be used. The switching frequency defined for this example (2.5 kHz) thus attends WEG's recommendation.

Therefore the motor designed fully attend this application's demands with regard to the insulation system.

However, it will not be possible to evaluate the matter on the point of view of IEC, because it requires the measurement of the voltage at the motor terminals. As the VSD system is still at the dimensioning stage and there is no actual motor at the application, it is understood that the final motor environment is not defined yet, so that measures are still made unfeasible and the actual voltage peak and rise time values at the motor terminals are unknown. Such values will depend on type and length of the cable employed at the end installation.

8.2.2.3 Regarding the bearings' protection

According to WEG criteria regarding protection against bearing currents (clause 6.9), WEG motors may optionally have protected bearings above (including) 504 NEMA (315 IEC) frames. The selected motor frame is 215T NEMA, thus needing neither shaft earthing system nor special insulated bearings.

8.3 Special application - long cable

8.3.1 Example

Evaluation of the voltage peaks at the terminals of a special WEG motor rated 9 kW – 2115 rpm – 500 V – 72 Hz. Due to matters intrinsic to the application, the motor must be fed by a PWM inverter through a 100 m long cable.

8.3.2 Solution

Supposing that the derating, bearing protection and noise criteria have already been verified and that the motor in question fully attends them, the insulation system of the motor is still left to be evaluated. It must be assured that the motor insulation will bear the application's conditions.

Owing to the long length of the cable leads there is the chance of excessive voltage peaks (overshoots) to occur at the motor terminals and therefore special attention must be addressed to the insulation matter. In this case, for an appropriate evaluation of the insulation system, the highest speed within the operating range must be considered, in order that maximum voltage levels come to the motor terminals, causing the voltage peaks to be as high as possible, as well.

According to the insulation criteria of WEG motors (clause 6.6), induction machines rated 500 V are able to bear voltage peaks up to 1780 V and dV/dt up to 6500 V/ μ s.

In this case it will be possible to analyze the voltage peaks at the motor terminals as requires IEC, once the actual installation exists and the factors decisively influencing the occurrence and gravity of overshoots are well defined.

The next waveforms were obtained by means of measurements accomplished at the inverter terminals (upper curves – PWM signal before the cable) and at the motor terminals (lower curves - PWM signal after the cable). It is important to stand out, that the voltage profiles appearing at the motor input would change if other cable were used. The cable used herein was not shielded and comprised of 4 conductors (3 phases + earth) asymmetrically distributed.

The inverter was fed by sinusoidal 500 V / 50 Hz voltage and scalar control with switching frequency 4 kHz was used.

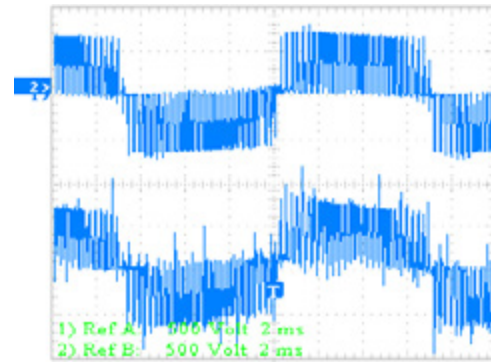

- Upper curve: PWM voltage leaving the inverter
- Lower curve: PWM voltage arriving at the motor

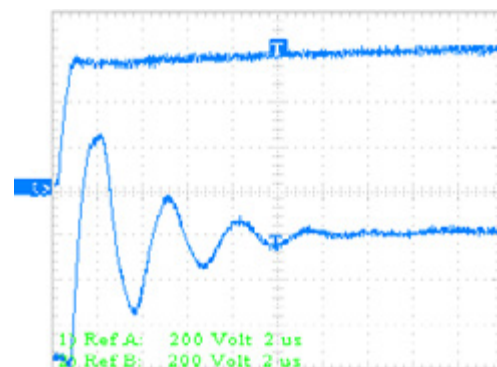

Zoom in the voltage pulse shown beside, for an analysis of t_r and V_{peak} .

Magnitude of the voltage peak appearing at the motor terminals

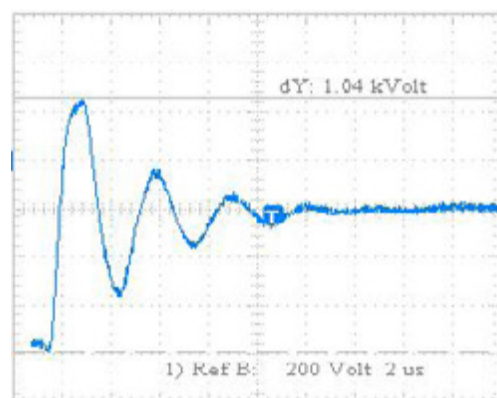

$$V_{peak} \cong 1040 \text{ V}$$

- WEG criterion \Rightarrow 1780 V (>1040 V) \Rightarrow Ok!
- NEMA criterion \Rightarrow 3,1.500 = 1550 V (< 1780 V) \Rightarrow Ok!
- IEC criterion \Rightarrow \cong 1300 V (< 1780 V) \Rightarrow Ok!

Rise time

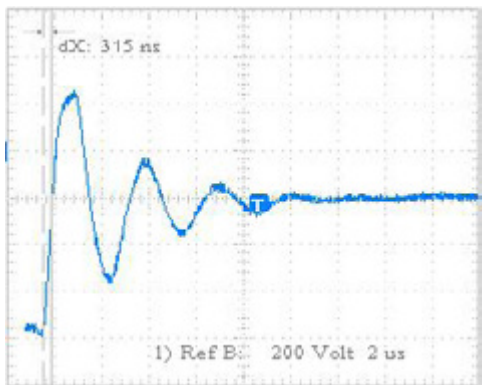

$$t_r \approx 0,8 \cdot 0,315 = 0,25 \mu s = \Delta t$$

WEG criterion $\Rightarrow 0,1 \mu s$ (minimum) at the inverter terminals \Rightarrow Ok!
 NEMA criterion $\Rightarrow 0,1 \mu s$ (minimum) at the inverter terminals \Rightarrow Ok!

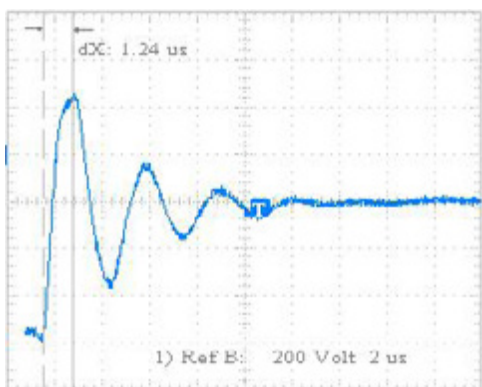

$$t_r \approx 0,8 \cdot 1,24 = 0,99 \mu s = \Delta t$$

IEC criterion \Rightarrow do not establish minimum value for t_r at motor terminals

dV/dt

At inverter terminals:

$$\Delta V = 0,8 \cdot V_{link,DC} = 0,8 (500 \cdot 1,414) = 565,6 \text{ V}$$

$$\Delta t = 0,25 \mu s$$

$$dV/dt \approx \Delta V/\Delta t = 2262,7 \text{ V}/\mu s$$

At motor terminals:

$$\Delta V = 0,8 \cdot V_{pico} = 0,8 \cdot 1040 = 832 \text{ V}$$

$$\Delta t = 0,99 \mu s$$

$$dV/dt \approx \Delta V/\Delta t = 840,4 \text{ V}/\mu s$$

WEG criterion $\Rightarrow 6500 \text{ V}/\mu s (> 2262,7 \text{ V}/\mu s) \Rightarrow$ Ok!
 NEMA criterion $\Rightarrow 6500 \text{ V}/\mu s \Rightarrow$ Ok!
 IEC criterion $\Rightarrow 840,4 \text{ V}/\mu s (< 6500 \text{ V}/\mu s) \Rightarrow$ Ok!

MTBP (minimum time between successive pulses)

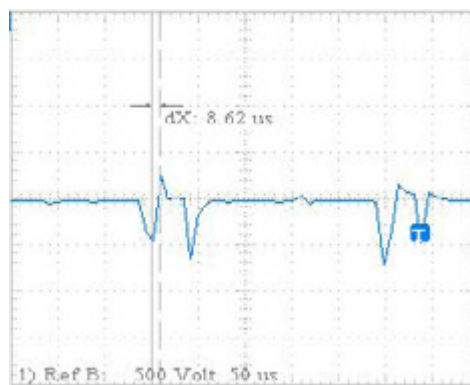
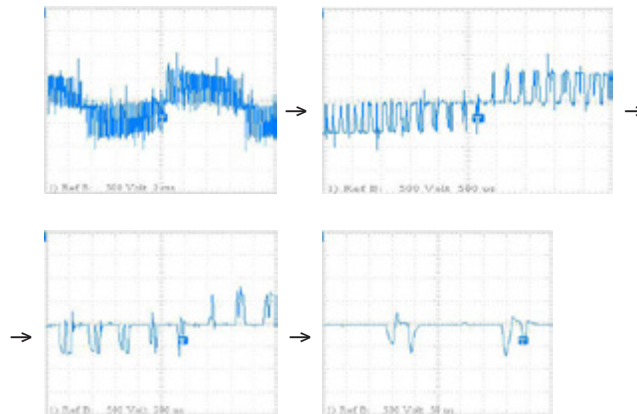

$$MTBP \approx 8,6 \mu s$$

(the waveform shown beside is the very waveform shown in the other figures throughout this example, but a convenient zoom was given to it in order to benefit the evaluation of the minimum time between successive pulses).

WEG criterion = $6 \mu s$ (minimo) \Rightarrow Ok!

So all the insulation criteria of WEG motors are attended and therefore the use of filters is not necessary. However, these conclusions are valid strictly for the ensemble (inverter – motor – cable leads) investigated. As mentioned before, the utilization of other cable or inverter would cause the voltage peaks at the motor terminals to change.

8.4 Variable torque / variable speed application - textile industry

8.4.1 Example

A standard IP55 squirrel cage induction WEG motor must be dimensioned for a textile industry application and may be driven by a frequency inverter unknown.

Application info:

- 50 Nm at full load
- Speed range from 540 to 3600 rpm
- Temperature rise of thermal class B (80 K) wanted on the windings

- Direct coupling
- Duty cycle as shown below
- No forced ventilation wanted

General data:

- Mains: 3 phase / 380 V / 60 Hz
- Room temperature 40°C, altitude 1000 m

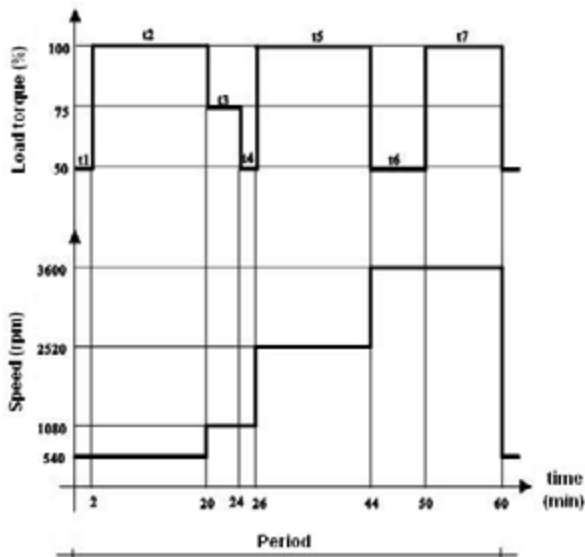

8.4.2 Solution

Considering the operation range (from 540 to 3600 rpm) and the base frequency (60 Hz), a 2 pole motor must be chosen, because higher polarities would lead to high operating frequencies and increasing torque reduction above 60 Hz. At base speed, neglecting the slip the load demands:

$$P_{(CV)} = \frac{Tr (kgfm) \cdot n (rpm)}{716} = \left(\frac{50}{9,81} \right) \frac{3600}{960} = 18,72 \text{ kW}$$

According to WEG standard motors' torque derating criteria valid for constant flux (constant V/f) condition (subclause 6.4.1.2), for operation at 60 Hz (1 per unit) the torque must be reduced to 0.95 per unit in order for the temperature rise of the machine to attend the limits of thermal class B. However, it is not possible to reduce in 5% the load, because it demands constant torque. Since the use of independent ventilation is also out of question, the motor has to be oversized. Thus the motor rated horsepower is actually higher than the value firstly reckoned:

$$P = \frac{18,72}{0,95} = 19,70 \text{ kW}$$

Consulting the WEG Stock Products Catalog, the standard motor which better fits the application has 22 kW and 2 poles. If the duty cycle were continuous, with full load full time and no speed variation, the dimensioning would be well done so and already concluded. Nevertheless the actual duty cycle embraces speed changes and different load percentages. Therefore, in order to achieve a suitable thermal dimensioning, the load demand at every operating condition must be analyzed, so that a motor equivalent torque can be finally calculated considering the whole duty cycle. Once obtained the equivalent torque, it must be assured that the chosen motor will be able to provide the maximum horsepower demanded throughout the operation duty. Assuming that the temperature rise is directly proportional to the losses and that the Joule losses comprise the prevailing component of motor losses, then the losses vary as the square of the speed and the equation below is true:

$$T_{eq} = \frac{\sqrt{\sum_{i=1}^7 \left(\frac{T_i}{df_i} \right)^2 t_{if}}}{\sum_{i=1}^7 t_i}$$

where,

T_{eq} : equivalent torque of the motor

T_i : torque demanded by the load at each operating speed

df_i : derating factor to be applied at each operating speed, due to the temperature rise increase occasioned by both harmonics and ventilation reduction;

t_i : period of each duty stretch, considered as below.

$$t_i = t_{if} + t_{ip}/k_v$$

t_{if} : time intervals with motor running (either loaded or not)

t_{ip} : sum of time intervals with motor stopped

k_v : constant value that depends on the motor cooling.

When ventilation does not depend on motor operation (for instance, TENV motors), then $k_v=1$.

When ventilation is linked to motor operation (for instance, TEFC motors), then $k_v=3$.

It is thus necessary to calculate the derating factor (df) suitable to each stretch of the duty cycle:

Period [min]	2	18	4	2	18	6	10
Torque p.u.	0,50	1,00	0,75	0,50	1,00	0,50	1,00
Torque [kgfm]	2,50	5,00	3,75	2,50	5,00	2,50	5,00
Speed [rpm]	540	540	1080	1080	2520	3600	3600
Frecuence [Hz]	9	9	18	18	42	60	60
Frecuence p.u.	0,15	0,15	0,30	0,30	0,70	1,00	1,00
Derating factor* (df)	0,65	0,65	0,77	0,77	0,91	0,95	0,95

* According to WEG derating criteria for standard motors under constant flux (constant V/f) condition (subclause 6.4.1.2)

Thus,

$$T_{eq} = \sqrt{\frac{\left(\frac{T_{50\%}}{0,65}\right)^2 \cdot 2 + \left(\frac{T_{100\%}}{0,65}\right)^2 \cdot 18 + \left(\frac{T_{75\%}}{0,77}\right)^2 \cdot 4 + \left(\frac{T_{50\%}}{0,77}\right)^2 \cdot 2 + \left(\frac{T_{100\%}}{0,91}\right)^2 \cdot 18 + \left(\frac{T_{50\%}}{0,95}\right)^2 \cdot 6 + \left(\frac{T_{100\%}}{0,95}\right)^2 \cdot 10}{(2+18+4+2+18+6+10)}}$$

$$T_{eq} = \sqrt{\frac{(2,50)^2 \cdot 2 + (5,00)^2 \cdot 18 + (3,75)^2 \cdot 4 + (2,50)^2 \cdot 2 + (5,00)^2 \cdot 18 + (2,50)^2 \cdot 6 + (5,00)^2 \cdot 10}{(2+18+4+2+18+6+10)}}$$

$$T_{eq} = \sqrt{\frac{(3,85)^2 \cdot 2 + (7,69)^2 \cdot 18 + (4,87)^2 \cdot 4 + (3,25)^2 \cdot 2 + (5,49)^2 \cdot 18 + (2,63)^2 \cdot 6 + (5,26)^2 \cdot 10}{(2+18+4+2+18+6+10)}} = \sqrt{\frac{2072,60}{60}} = 5,88 \text{ kgfm}$$

The load demands the following horsepower then:

$$P = \left(\frac{58,8}{9,81} \right) \frac{3600}{960} = 22,48 \text{ kW} = 30,14 \text{ hp}$$

Consulting the WEG Electric Motors Manual, for 3600 rpm and 60 Hz, the ideal motor for this application is a three-phase 30 kW (40 hp), 2 poles, 60 Hz, frame IEC 200M (NEMA 324T) TEFC.

8.5 Example considering the use of WEG Optimal Flux

8.5.1 Example

Considering the same application of the last example, please dimension a self-ventilated squirrel cage induction WEG Premium Efficiency motor to be driven by a frequency inverter WEG model CFW-09 (software version 2.40). It is desired temperature rise of thermal class F (105 K).

8.5.2 Solution

Observing the motor line (Premium Efficiency) and the inverter characteristics (CFW09 version 2.40 or higher) it is remarkable that in this case the optimal flux can be beneficially used. This example aims to evidence the advantages provided by the employment of the optimal flux solution.

It will be necessary to reckon again the derating factor (df) applicable at each stretch of the duty cycle, but this time according to the torque derating criteria valid for Premium Efficiency motors at optimal flux condition (subclause 6.4.1.2), considering the temperature rise of class "F".

Period [min]	2	18	4	2	18	6	10
Torque p.u.	0,50	1,00	0,75	0,50	1,00	0,50	1,00
Torque [kgfm]	2,50	5,00	3,75	2,50	5,00	2,50	5,00
Speed [rpm]	540	540	1080	1080	2520	3600	3600
Frequency [Hz]	9	9	18	18	42	60	60
Frequency p.u.	0,15	0,15	0,30	0,30	0,70	1,00	1,00
Derating factor* (df)	1,00	1,00	1,00	1,00	1,00	1,00	1,00

* According to WEG torque derating criteria valid for high efficiency motors under optimal flux (optimal V/f) condition (subclause 6.4.1.2)

Thus,

$$T_{eq} = \sqrt{\frac{\left(\frac{T_{50\%}}{1,00}\right)^2 \cdot 2 + \left(\frac{T_{100\%}}{1,00}\right)^2 \cdot 18 + \left(\frac{T_{75\%}}{1,00}\right)^2 \cdot 4 + \left(\frac{T_{50\%}}{1,00}\right)^2 \cdot 2 + \left(\frac{T_{100\%}}{1,00}\right)^2 \cdot 18 + \left(\frac{T_{50\%}}{1,00}\right)^2 \cdot 6 + \left(\frac{T_{100\%}}{1,00}\right)^2 \cdot 10}{(2+18+4+2+18+6+10)}}$$

$$T_{eq} = \sqrt{\frac{(2,50)^2 \cdot 2 + (5,00)^2 \cdot 18 + (3,75)^2 \cdot 4 + (2,50)^2 \cdot 2 + (5,00)^2 \cdot 18 + (2,50)^2 \cdot 6 + (5,00)^2 \cdot 10}{(2+18+4+2+18+6+10)}} = \sqrt{\frac{1268,75}{60}} = 4,60 \text{ kgfm}$$

The load demands the following horsepower then:

$$P = \left(\frac{45,98}{9,81} \right) \frac{3600}{960} = 17,58 \text{ kW} = 23,58 \text{ hp}$$

Consulting the WEG Electric Motors Manual, for 3600 rpm and 60 Hz, the ideal motor for this application is a three-phase 18,5 kW (25 hp), 2 poles, 60 Hz, frame IEC 160M (NEMA 284T) TEFC. It was thereby shown that the optimal flux solution provides a better utilization of the energy, allowing for a smaller frame motor to attend the application needs yet not using forced ventilation or oversizing.

9 Recommendations for the measurement of PWM waveforms

9.1 Warning

The measurements dealt with in this clause involve potentially lethal voltage and current levels. Only qualified individuals, familiar with the construction and operation of the equipment and hazards involved should take these measurements.

9.2 Instrumentation

Frequency inverters supply motors with PWM voltage, which is non-sinusoidal. Measurements of such voltages must be taken with proper equipments in order to be reliable. Modern digital measurement instruments that are able to read true rms values must be used. Some of them will not read the fundamental component of a PWM waveform though. Harmonic measurement instruments with fast enough sampling rate are capable of reading both rms and fundamental values of voltage, current and power. An oscilloscope with isolated probes and proper bandwidth is appropriate in most cases.

9.3 Parameter measurements

According to the NEMA Application Guide for AC ASD Systems, the recommended instrumentation for the measurement of various parameters should be as described in the table below.

Recommended instrumentation for the measurement of various parameters

Parameter	Typical Reading	Instrumentation Required	Reason
Control input voltage	Fundamental	Analog or digital voltmeter	Very control input voltage
	Transient	20 MHz or higher storage oscilloscope	Capture line voltage variation
Control output voltage or motor input voltage	Fundamental	A meter capable of measuring fundamental of a non-sinusoidal wave form	Very motor input voltage
	Peak transient and dV/dt	Oscilloscope with a sampling rate of at least 1Ms/sec	Compare to the motor's peak voltage and rise-time with sand capability
Control input current	True ms	True ms meter	Very feeder size
Control output current or motor input voltage	True ms	True ms meter	Estimate overheating
	Fundamental	A meter capable of measuring fundamental of a non-sinusoidal wave form	Estimate torque
Input voltage harmonics	Fundamental plus harmonics	Spectrum analyzer	Ensure compliance with IEEE-519
Input current harmonics	Fundamental plus harmonics	Spectrum analyzer	Ensure compliance with IEEE-519
Drive efficiency	NA	NA	Not practical due to difficulty of accurately measuring motor output in situ

9.4 Grounding considerations

Safe, reliable and interference-free measurements depend on good grounding practices. The manufacturer's recommendations as well as local regulations concerning grounding must always be followed when installing ground wiring.

9.4.1 Grounding of control

The control must be solidly grounded to the main distribution system ground. A ground common with electrical welding equipment or large current electrical equipment (typically 5x rating of the control) should not be used. If either of these conditions exist an isolation transformer sized for the installed control with a wye secondary neutral solidly grounded should be used. Where more than one control is used, each of them should be grounded directly to the system ground terminal - they should not be loop grounded nor installed in series.

9.4.2 Grounding of motor

The output ground conductor may be run in the same conduit as the AC motor power leads. The grounded metal conduit carrying the output power conductors can provide EMI shielding, but it does not provide an adequate ground for the motor; a separate ground conductor should be used. The motor's ground wire should not be connected to the metallic conduit.

9.5 Measurement procedures

Actual operation conditions (especially concerning motor speed, control type and switching frequency) should be attended when taking measurements. It is worth noting that higher speeds imply higher voltage levels and therefore operation at the highest speed within the operation frequency range will probably result in the highest possible voltage peaks at the motor terminals.

9.5.1 Waveform visualization

The correct evaluation of a VSD System strongly depends on a proper analysis of the waveforms measured. The visualization of **one cycle** (or specific parts of a cycle) of the PWM voltage waveform at the motor terminals gives an idea about the pulses' quality at the motor terminals. For a better verification of the consistency of these pulses, the visualization of **two or three cycles** is recommended, once it evidences the repetitiveness of such pulses. A detailed analysis of a **single pulse** finally allows that conclusions about the rise time and the intensity of the peak voltages be found.

9.5.2 Oscilloscope scale setting

The better choice of which scale should be adopted while taking measurements will evidently depend on the magnitudes of the electrical quantities being measured. However, the ranges shown in the table below are commonly suitable for 50/60 Hz measurements and can be used as a first orientation.

Suggestions of oscilloscope's scale setting

Visualization	X-axis	Y-axis
1 cycle	1 ↔ 2 ms / div	100 ↔ 500 V / div
3 cycles	5 ↔ 10 ms / div	100 ↔ 500 V / div
1 pulse	0.1 ↔ 10 μs / div	100 ↔ 500 V / div

9.5.3 Triggering

Oscilloscopes are instruments ordinarily employed for metering and not for monitoring electrical quantities. In spite of that, the trigger of some modern oscilloscopes can be suitably set, so that it is enabled to hold data of particular interest, for instance waveforms of voltage peaks taken during transient conditions such as acceleration and deceleration periods. Further information on this topic can be found in the User's Manual of the instrument.

10 Conclusion

The fast advance of the power electronics have allowed induction motors, the traditional solution for fixed speed rotating power applications, to be used successfully also in variable speed drive systems. In such cases, though, the motor must be fed by means of a static frequency inverter, rather than directly by the (sinusoidal) power line.

The utilization of squirrel cage induction motors with electronic inverters presents great advantages regarding costs and energy efficiency, compared with other industrial solutions for varying speed applications. Nevertheless, the inverter affects the motor performance and might introduce disturbs into the mains power line.

The increasing number of applications with induction motors fed by PWM inverters operating in variable speed duty thus requires a good understanding of the whole power system as well as the interactions among its parts one another (power line – frequency inverter – induction motor – load).

This Technical Guide aimed to clarify the main aspects related to the application of squirrel cage induction motors together with static frequency inverters, presenting theoretical basics and practical criteria for specific topics, originated from studies and from the experience of WEG's technical body in this subject. The most important and internationally recognized technical references concerned with such matters are mentioned and also discussed.

It must be finally considered that the criteria presented here are not permanent. Like every technology, they may change as new materials are developed and new experiences are accomplished. So the application criteria established so far may be altered without previous advice and therefore it is important that this document be periodically revised and updated.

11 Bibliography

- NEMA MG1 Part 30 - Application considerations for constant speed motors used on a sinusoidal bus with harmonic content and general purpose motors used with adjustable-frequency controls or both (2006)
- NEMA MG1 Part 31 - Definite-purpose inverter-fed polyphase motor (2006)
- NEMA - Application Guide for AC Adjustable Speed Drive Systems (2001)
- IEC 60034-17 - Cage induction motors when fed from inverters – application guide (2006)
- IEC 60034-25 - Guide for the design and performance of cage induction motors specifically designed for inverter supply (2007)
- GAMBICA/REMA Technical Guides for Variable Speed Drives and Motors
- GAMBICA/REMA Technical Reports for Variable Speed Drives and Motors
- Brochure of the mini-course Squirrel Cage Induction Motors Fed by PWM Frequency Inverters – R&D of the Product Department – WEG Equipamentos Elétricos S.A. – Motores
- WEG Stock Products Catalog
- WEG NEMA Motors Catalog
- User's Guide of the CFW-09
- Technical Reports of the R&D Department – WEG Equipamentos Elétricos S.A. – Motores
- WEG Technological Reports (TT 2000-002, TT 2003-011)
- Technical Notes of the Development of Products Department – WEG Equipamentos Elétricos S.A. – Automação
- Minimization of Losses in Inverter-Fed Induction Motors – Optimal Flux Solution – Waldiberto L. Pires and Hugo G. G. Mello – PCIC BR 2006

- Low-Voltage PWM Inverter-Fed Motor Insulation Issues – Michael J. Melfi – IEEE Transactions on Industry Applications, vol.42

WEG Worldwide Operations

ARGENTINA

San Francisco - Cordoba
Phone: +54 3564 421484
info-ar@weg.net

Cordoba - Cordoba
Phone: +54 351 4641366
weg-morbe@weg.com.ar

Buenos Aires
Phone: +54 11 42998000
ventas@pulverlux.com.ar

AUSTRALIA

Scoresby - Victoria
Phone: +61 3 97654600
info-au@weg.net

AUSTRIA

Markt Piesting - Wiener
Neustadt-Land
Phone: +43 2633 4040
watt@wattdrive.com

BELGIUM

Nivelles - Belgium
Phone: +32 67 888420
info-be@weg.net

BRAZIL

Jaraguá do Sul - Santa Catarina
Phone: +55 47 32764000
info-br@weg.net

CHILE

Santiago
Phone: +56 2 27848900
info-cl@weg.net

CHINA

Nantong - Jiangsu
Phone: +86 513 85989333
info-cn@weg.net

Changzhou - Jiangsu
Phone: +86 519 88067692
info-cn@weg.net

COLOMBIA

San Cayetano - Bogota
Phone: +57 1 4160166
info-co@weg.net

ECUADOR

El Batan - Quito
Phone: +593 2 5144339
ceccato@weg.net

FRANCE

Saint-Quentin-Fallavier - Isère
Phone: +33 4 74991135
info-fr@weg.net

GERMANY

Türnich - Kerpen
Phone: +49 2237 92910
info-de@weg.net

Balingen - Baden-Württemberg
Phone: +49 7433 90410
info@weg-antriebe.de

Homburg (Efze) - Hesse
Phone: +49 5681 99520
info@akh-antriebstechnik.de

GHANA

Accra
Phone: +233 30 2766490
info@zestghana.com.gh

INDIA

Bangalore - Karnataka
Phone: +91 80 41282007
info-in@weg.net

Hosur - Tamil Nadu
Phone: +91 4344 301577
info-in@weg.net

ITALY

Cinisello Balsamo - Milano
Phone: +39 2 61293535
info-it@weg.net

JAPAN

Yokohama - Kanagawa
Phone: +81 45 5503030
info-jp@weg.net

MALAYSIA

Shah Alam - Selangor
Phone: +60 3 78591626
info@wattdrive.com.my

MEXICO

Huehuetoca - Mexico
Phone: +52 55 53214275
info-mx@weg.net

Tizayuca - Hidalgo
Phone: +52 77 97963790

NETHERLANDS

Oldenzaal - Overijssel
Phone: +31 541 571080
info-nl@weg.net

PERU

La Victoria - Lima
Phone: +51 1 2097600
info-pe@weg.net

PORTUGAL

Maia - Porto
Phone: +351 22 9477700
info-pt@weg.net

RUSSIA and CIS

Saint Petersburg
Phone: +7 812 363 2172
sales-wes@weg.net

SOUTH AFRICA

Johannesburg
Phone: +27 11 7236000
info@zest.co.za

SPAIN

Coslada - Madrid
Phone: +34 91 6553008
wegiberia@wegiberia.es

SINGAPORE

Singapore
Phone: +65 68589081
info-sg@weg.net

Singapore
Phone: +65 68622220
watteuro@watteuro.com.sg

SCANDINAVIA

Mölnlycke - Sweden
Phone: +46 31 888000
info-se@weg.net

UK

Redditch - Worcestershire
Phone: +44 1527 513800
info-uk@weg.net

UNITED ARAB EMIRATES

Jebel Ali - Dubai
Phone: +971 4 8130800
info-ae@weg.net

USA

Duluth - Georgia
Phone: +1 678 2492000
info-us@weg.net

Minneapolis - Minnesota
Phone: +1 612 3788000

VENEZUELA

Valencia - Carabobo
Phone: +58 241 8210582
info-ve@weg.net

For those countries where there is not a WEG own operation, find our local distributor at www.weg.net.



WEG Group - Motors Business Unit
Jaraguá do Sul - SC - Brazil
Phone: +55 47 3276 4000
motores@weg.net
www.weg.net

